

New AC Drives Family Delivers Excellent Performance and Value



AC Drives Reduce Motor Wear and Improve Energy Efficiency to Reduce Your Operating Costs

- » Three models address simple to complex needs
- » Space- and energy-saving features
- » Easy-to-apply advanced functions
- » High torque at low frequencies

Simple, Compact Inverters

SYSDRIVE JX Series

Nomenclature and Functions



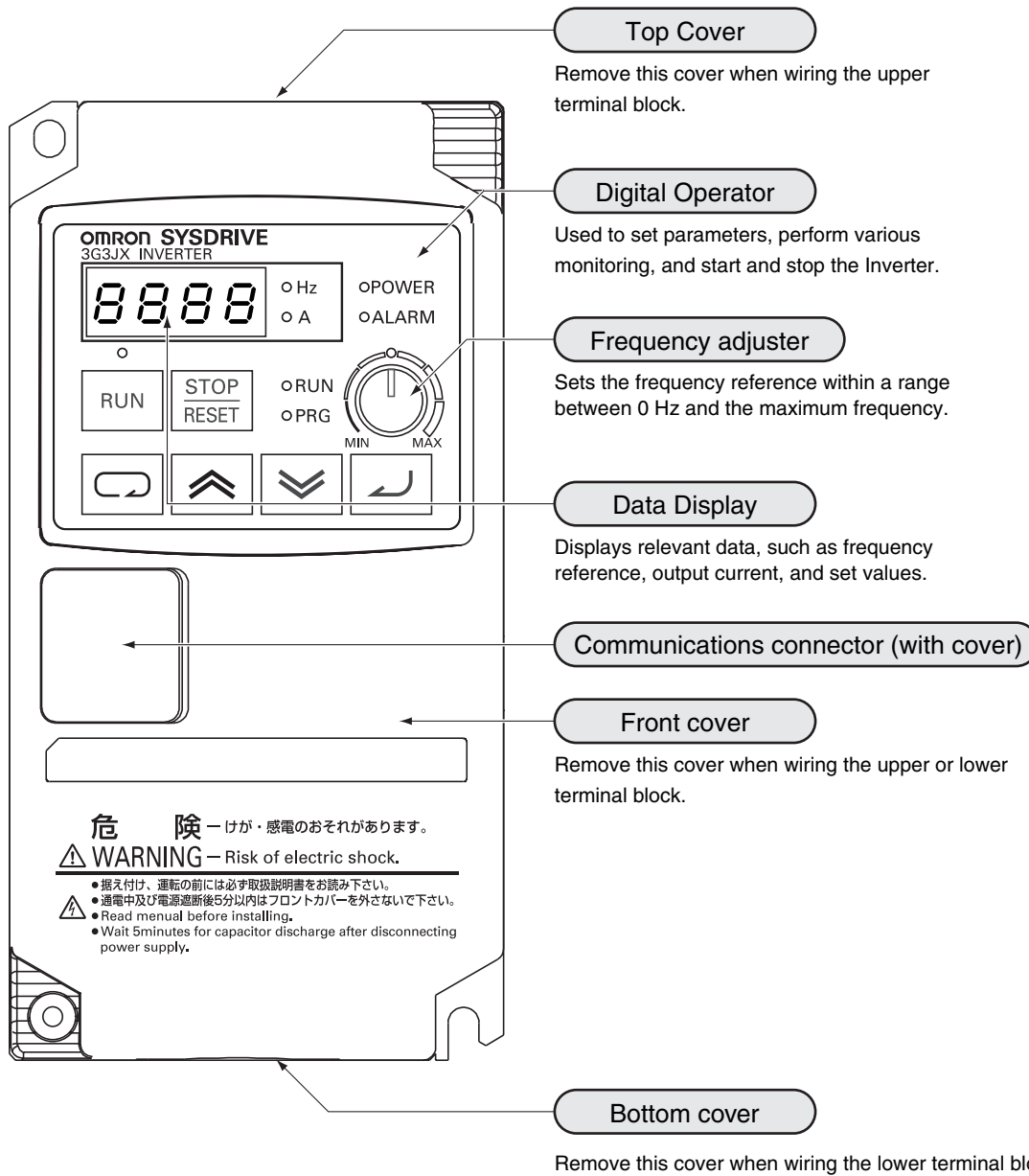



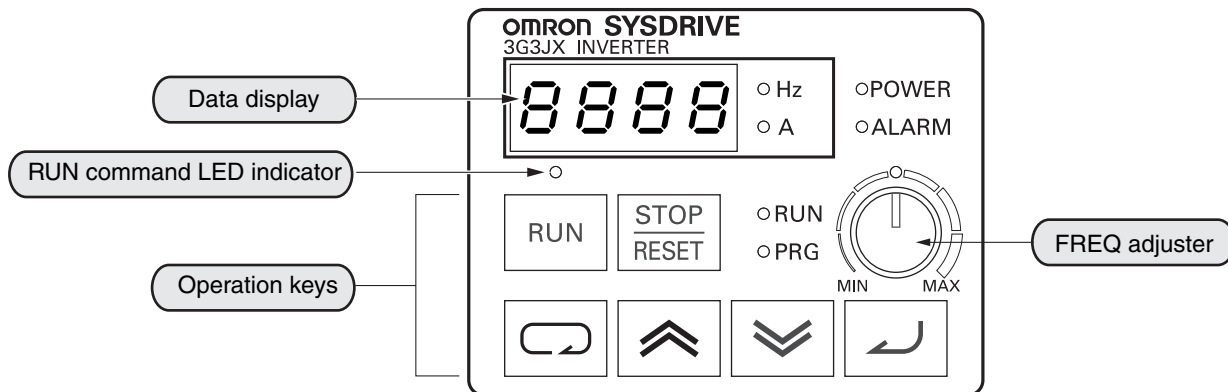

■ Inverter Nomenclature and Functions

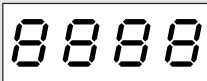

- Note 1.** Connect the communications cable after opening the cover of the communications connector. Remove the front cover to switch communications.
Note 2. The cover of the communications connector is removable. Remove the front cover to attach it.

■ Part Names and Descriptions of the Digital Operator



	Name	Description
○POWER	POWER LED indicator	Lit when the power is supplied to the control circuit.
○ALARM	ALARM LED indicator	Lit when an Inverter error occurs.
○RUN	RUN (during RUN) LED indicator	Lit when the Inverter is running.
○PRG	PROGRAM LED indicator	Lit when the set value of each function is indicated on the data display. Blinks during warning (when the set value is incorrect).
	Data display	Displays relevant data, such as frequency reference, output current, and set values.
○ Hz ○ A	Data display LED indicator	Lit according to the indication on the data display. Hz: Frequency A: Current
	Volume LED indicator	Lit when the frequency reference source is set to the FREQ adjuster.
	FREQ adjuster	Sets a frequency. Available only when the frequency reference source is set to the FREQ adjuster. (Check that the Volume LED indicator is lit.)
○	RUN command LED indicator	Lit when the RUN command is set to the Digital Operator. (The RUN key on the Digital Operator is available for operation.)
	RUN key	Activates the Inverter. Available only when operation via the Digital Operator is selected. (Check that the RUN command LED indicator is lit.)
	STOP/RESET key	Decelerates and stops the Inverter. Functions as a reset key if an Inverter error occurs.
	Mode key	Switches between the monitor mode (d□□□), the basic function mode (F□□□), and the extended function mode (A□□□, b□□□, c□□□, H□□□).
	Enter key	Enters the set value. (To change the set value, be sure to press the Enter key.)
	Increment key	Changes the mode. Also, increases the set value of each function.
	Decrement key	Changes the mode. Also, decreases the set value of each function.

Using Digital Operator

1. Setting the maximum output frequency

Power ON

(1) 0.0 or the value previously monitored is displayed.

(5) A004 appears.

Press key.

Press key.

(2) Function code appears.

(6) Preset value is displayed.

Press until A --- appears.

Press to set desired value.

(3) A --- appears.

(7) Newly set value is displayed.

Press key.

Press key to store the value.

(4) A001 or the code number set in the end of last setting is displayed.

(8) Returns to A004 and the setting is complete.

Press until A --- appears.

- To run the motor, go back to monitor mode or basic setting mode.
- Pressing key for a while and back to d001.

(It continues in upper right.)

2. Running the motor (by potentiometer)

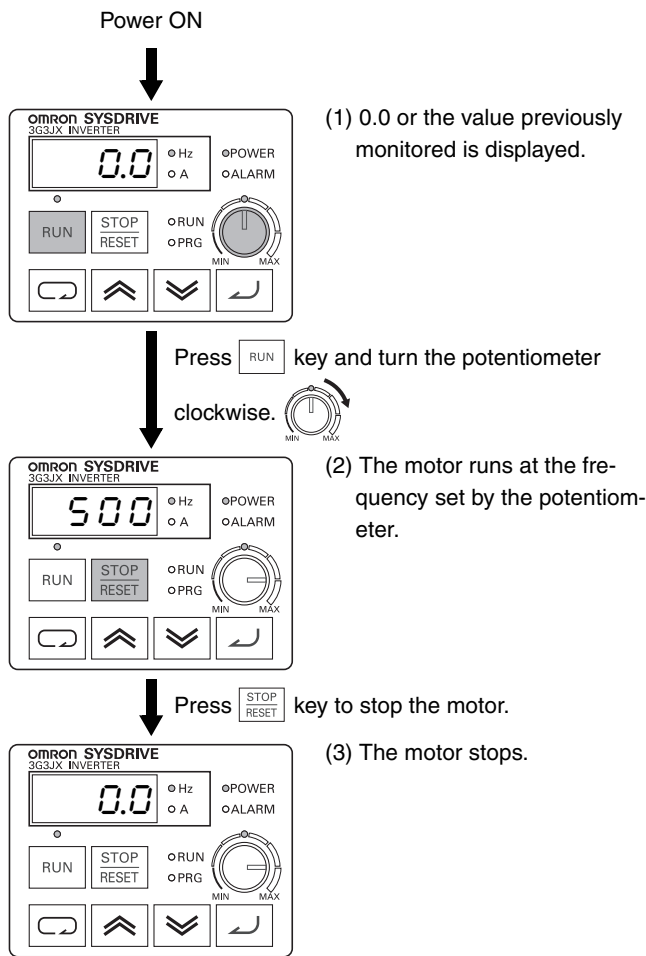

3. Monitoring output current value

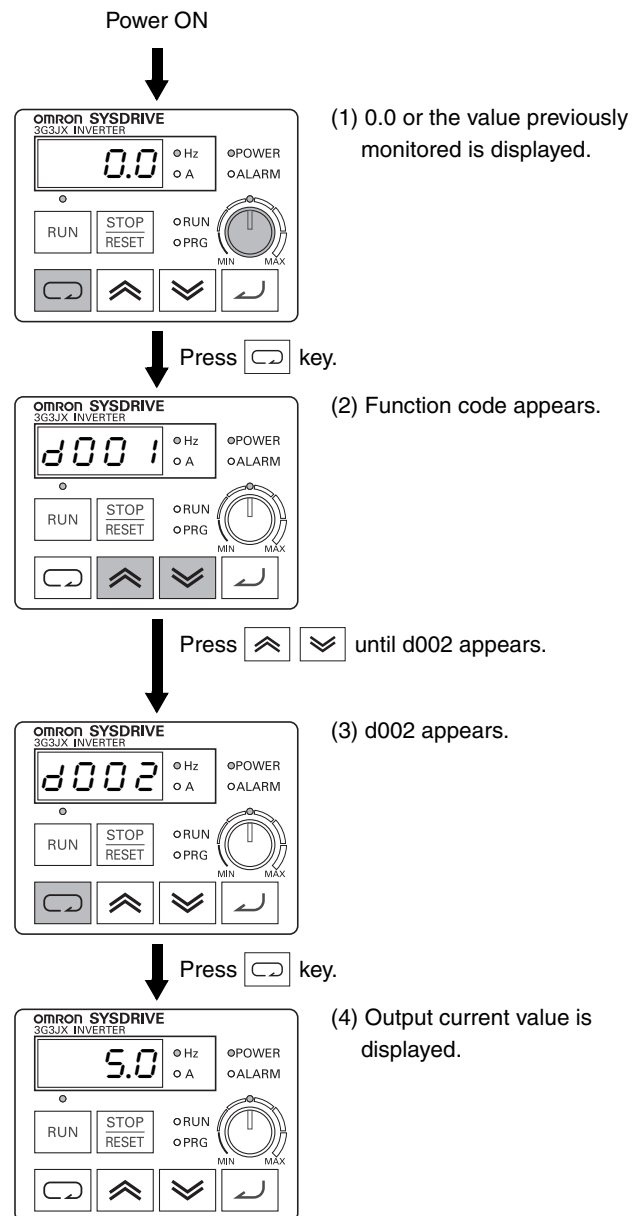

Standard Specification List

●200-V Class

Item Model name (3G3JX-)		3-phase 200-V class					
		A2002	A2004	A2007	A2015	A2022	A2037
Applicable motor capacity ^{*1}	kW	0.2	0.4	0.75	1.5	2.2	3.7
	HP	1/4	1/2	1	2	3	5
Rated output capacity (kVA)	200 V	0.4	0.9	1.3	2.4	3.4	5.5
	240 V	0.5	1.0	1.6	2.9	4.1	6.6
Rated input voltage		3-phase (3-wire) 200 V -15% to 240 V +10%, 50/60 Hz ±5%					
Built-in filter		Zero-phase reactor					
Rated input current (A)		1.8	3.4	5.2	9.3	13.0	20.0
Rated output voltage ^{*2}		3-phase: 200 to 240 V (Cannot exceed that of incoming voltage.)					
Rated output current (A)		1.4	2.6	4.0	7.1	10.0	15.9
Weight (kg)		0.8	0.9	1.1	2.2	2.4	2.4
Cooling method		Self-cooling			Forced-air-cooling		
Braking torque	At short-time deceleration ^{*3} At capacitor feedback	Approx. 50%			Approx. 20% to 40%		
	DC injection braking	Injection braking frequency/time, braking force variable, frequency control available					

●400-V Class

Item Model name (3G3JX-)		3-phase 400-V class				
		A4004	A4007	A4015	A4022	A4037
Applicable motor capacity ^{*1}	kW	0.4	0.75	1.5	2.2	3.7
	HP	1/2	1	2	3	5
Rated output capacity (kVA)	380 V	0.9	1.6	2.5	3.6	5.6
	480 V	1.2	2.0	3.1	4.5	7.1
Rated input voltage		3-phase (3-wire) 380 V -15% to 480 V +10%, 50/60 Hz ±5%				
Built-in filter		Zero-phase reactor				
Rated input current (A)		2.0	3.3	5.0	7.0	11.0
Rated output voltage ^{*2}		3-phase: 380 to 480 V (Cannot exceed that of incoming voltage.)				
Rated output current (A)		1.5	2.5	3.8	5.5	8.6
Weight (kg)		1.5	2.3	2.4	2.4	2.4
Cooling method		Self-cooling		Forced-air-cooling		
Braking torque	At short-time deceleration ^{*3} At capacitor feedback	Approx. 50%		Approx. 20% to 40%		
	DC injection braking	Injection braking frequency/time, braking force variable, frequency control available				

●1/3-phase 200-V Class

Item Model name (3G3JX-)		1/3-phase 200-V Class				
		AE002	AE004	AE007	AE015	AE022
Applicable motor capacity ^{*1}	kW	0.2	0.4	0.75	1.5	2.2
	HP	1/4	1/2	1	2	3
Rated output capacity (kVA)	200 V	0.4	0.9	1.3	2.4	3.4
	240 V	0.5	1.0	1.6	2.9	4.1
Rated input voltage		1/3-phase 200 V -15% to 240 V +10%, 50/60 Hz ±5%				
Built-in filter		None				
Rated input current (A)		1.8	3.4	5.2	9.3	13.0
Rated output voltage ^{*2}		3-phase: 200 to 240 V (Cannot exceed that of incoming voltage.)				
Rated output current (A)		1.4	2.6	4.0	7.1	10.0
Weight (kg)		0.8	0.9	1.5	2.3	2.4
Cooling method		Self-cooling			Forced-air-cooling	
Braking torque	At short-time deceleration ^{*3} At capacitor feedback	Approx. 50%			Approx. 20% to 40%	
	DC injection braking	Injection braking frequency/time, braking force variable, frequency control available				

Common Specifications

Item		Specifications
Enclosure rating *4		Semi-closed (IP20)
Control	Control method	Phase-to-phase sinusoidal modulation PWM
	Output frequency range *5	0.5 to 400 Hz
	Frequency precision *6	Digital command: ±0.01% of the max. frequency Analog command: ±0.4% of the max. frequency (25°C ±10°C)
	Frequency setting resolution	Digital setting: 0.1 Hz Analog setting: Max. frequency/1000
	Voltage/Frequency characteristics	V/f characteristics (constant/reduced torque)
	Overload current rating	150% for 1 min
	Acceleration/Deceleration time	0.01 to 3000 s (line/curve selection), 2nd acceleration/deceleration setting available
	Carrier frequency modification range	2 to 12 kHz
	DC injection braking	Starts at a frequency lower than that in deceleration via the STOP command, at a value set lower than that during operation, or via an external input. (Level and time settable.)
Protective functions		Overcurrent, overvoltage, undervoltage, electronic thermal, temperature error, ground-fault overcurrent at power-on state, overload limit, incoming overvoltage, external trip, memory error, CPU error, USP trip, communication error, overvoltage protection during deceleration, momentary power interruption protection, emergency shutoff
Input signal	Multi-function input	FW (forward), RV (reverse), CF1 to CF4 (multi-step speed), JG (jogging), DB (external DC injection braking), SET (2nd function), 2CH (2-step acceleration/deceleration), FRS (free run), EXT (external trip), USP (USP function), SFT (soft lock), AT (analog current input function selection), RS (reset), PTC (thermistor input), STA (3-wire startup), STP (3-wire stop), F/R (3-wire forward/reverse), PID (PID selection), PIDC (PID integral reset), UP (UP of UP/DWN function), DWN (DWN of UP/DWN function), UDC (data clear of UP/DWN function), OPE (forced OPE mode), ADD (frequency addition), F-TM (forced terminal block), RDY (operation ready), SP-SET (special setting), EMR (emergency shutoff)
Output signal	Multi-function output	RUN (signal during operation), FA1 (frequency arrival signal 1), FA2 (frequency arrival signal 2), OL (overload warning signal), OD (PID excess deviation signal), AL (alarm signal), DC (analog input disconnection detection signal), FBV (PID FB status output), NDc (network error), LOG (logical operation result), ODc (communication option disconnected), LOC (light load signal)
	Frequency monitor	Analog output (0 to 10 V DC, 1 mA max.) Frequency/Current signals are selectable via the AM output terminal.
	Relay output	The relay (SPDT contact) outputs signals corresponding to the multi-function output.
Other functions		AVR function, V/f characteristic selection, upper/lower limit, 16-step speeds, starting frequency adjustment, jogging operation, carrier frequency adjustment, PID control, frequency jump, analog gain/bias adjustment, S-shape acceleration/deceleration, electronic thermal characteristics/level adjustment, retry function, simplified torque boost, trip monitor, soft lock function, frequency conversion display, USP function, 2nd control function, motor rotation speed UP/DOWN, overcurrent suppression function
General specifications	Ambient temperature	-10°C to 50°C (Both the carrier frequency and output current need to be reduced at over 40°C.)
	Ambient storage temperature	-20°C to 65°C (short-time temperature during transport)
	Humidity	20% to 90% RH
	Vibration	5.9 m/s ² (0.6G), 10 to 55 Hz (Complies with the test method specified in JIS C0040 (1999).)
	Location	At a maximum altitude of 1,000 m; indoors (without corrosive gases or dust)
	Applicable standard	Complies with UL, cUL, CE standards. (Insulation distance)
Options		Noise filter, AC/DC reactors, regenerative braking unit and resistor, etc.

*1. The applicable motor is a 3-phase standard motor. For using any other type, be sure that the rated current does not exceed that of the Inverter.
 *2. Output voltage decreases according to the level of the power supply voltage.
 *3. The braking torque at the time of capacitor feedback is an average deceleration torque at the shortest deceleration (when it stops from 50 Hz), not a continuous regeneration torque. Also, the average deceleration torque varies depending on the motor loss. The value is reduced in operation over 50 Hz. Note that no regenerative braking circuit is built into the Inverter. If you need a larger regenerative torque, use the optionally available regenerative braking unit and resistor. The regenerative braking unit should be used only for short-time regeneration.
 *4. Protection method complies with JEM 1030.
 *5. To operate the motor at over 50/60 Hz, contact the motor manufacturer to find out the maximum allowable speed of revolution.
 *6. For the stable control of the motor, the output frequency may exceed the maximum frequency set in A004 (A204) by 2 Hz max.

■ Terminal Block Specifications

● Terminal Block Position

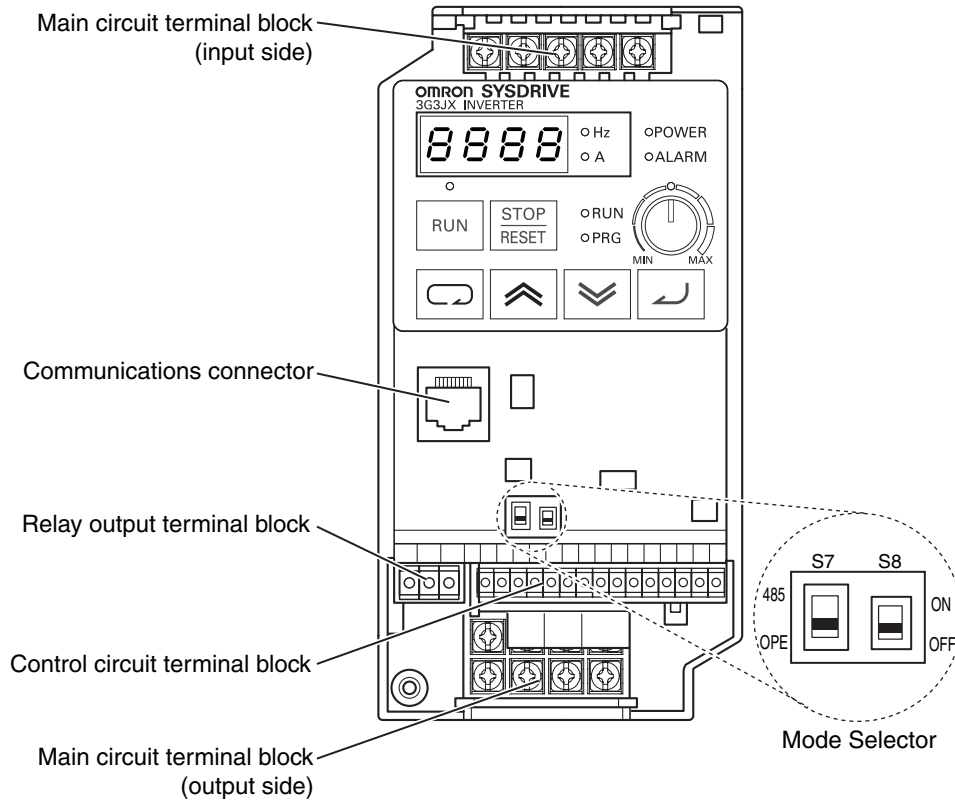

Note: This illustration shows the terminal block with the front cover removed.

● Specifications of Main Circuit Terminals

Upper side of the body



Lower side of the body

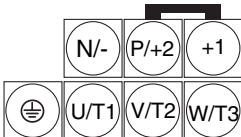

Terminal symbol	Terminal name	Function	Connection example
R/L1, S/L2, T/L3	Main power supply input terminal	Connect the input power supply.	<p>Do not remove the short-circuit bar between +1 and P/+2 when a DC reactor is not connected.</p>
U/T1, V/T2, W/T3	Inverter output terminal	Connect to the motor.	
+1, P/+2	External DC reactor terminal	Normally connected by the short-circuit bar. Remove the short-circuit bar between +1 and P/+2 when a DC reactor is connected.	
P/+2, N/-	Regenerative braking unit connection terminal	Connect optional regenerative braking units. (If a braking torque is required)	
⊕	Ground terminal	Ground (Connect to ground to prevent electric shock and reduce noise.)	

● Control Circuit Terminals Specifications

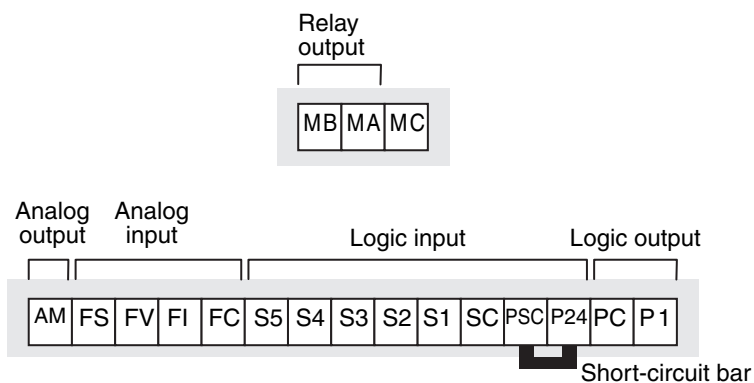

	Terminal symbol	Terminal name and function	Default setting	Note
Input signal	PSC	External power supply terminal for input signal (input) ...At sink logic Internal power supply output terminal for input signal (output) ...At source logic	---	24 V DC ±10% 30 mA max. 24 V DC ±10% 100 mA max.
	S1	Multi-function input terminals S1 to S5 Select 5 functions among the 31 functions and allocate them to from terminals S1 to S5. The terminal allocation is changed automatically when the emergency shutoff function is used.	Forward/Stop	Contact input Close: ON (Start) Open: OFF (Stop) Minimum ON time: 12 ms min.
	S2		Reverse/Stop	
	S3		Fault reset	
	S4		Emergency stop fault	
	S5		Multi-step speed reference 1	
	SC	Input signal common	---	
Monitor signal	AM	Analog frequency monitor/Analog output current monitor	Analog frequency monitor	
Frequency reference input	FS	Frequency reference power supply	---	10 V DC 10 mA max.
	FV	Voltage frequency reference signal	---	0 to 10 V DC Input impedance 10 kΩ When installing variable resistors at FS, FV, and FC (1 to 2 kΩ)
	FI	Current frequency reference signal	---	4 to 20 mA DC Input impedance 250 Ω
	FC	Frequency reference common	---	
Output signal	P1	Multi-function output terminal Select the status of the Inverter and allocate it to terminal P1.	Frequency arrival signal at a constant speed	27 V DC 50 mA max.
	PC	Output signal common	---	
Relay output signal	MA		Factory default relay settings Under normal operation: MA-MC Closed Under abnormal operation or power shutdown: MA-MC Open	
	MB			
	MC			

● Mode Selector

RS-485 Communication/Operator Selector (S7)

Select the mode according to the option connected to the communications connector.

When using the 3G3AX-OP01 supplied with the Inverter, it is available regardless of the switch condition.

Symbol	Name	Status	Description
S7	RS-485 communication/ operator selector	485	RS485 Modbus communication
		OPE [Default]	Digital Operator (Option: 3G3AX-OP1)

Emergency shutoff selector (S8)

Use this selector to enable the emergency shutoff input function.

Symbol	Name	Status	Description
S8	Emergency shutoff selector	ON	Emergency shutoff input enabled *
		OFF [Default]	Normal

* The multi-function input terminal 3 is switched to a terminal for emergency shutoff input, and the allocation of other multi-function input terminals is also changed automatically. Do not set to ON immoderately. For details, refer to "Emergency Shutoff Input Function".

Dimensions

- 3G3JX-A2002
- 3G3JX-A2004
- 3G3JX-A2007
- 3G3JX-AE002
- 3G3JX-AE004

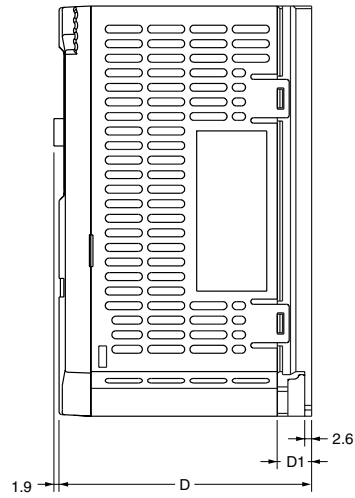
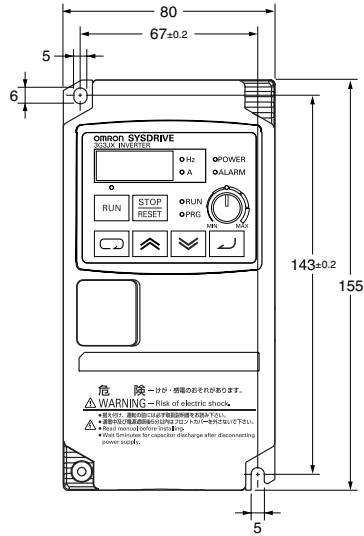

Rated voltage	Model 3G3JX-	Dimensions (mm)	
		D	D1
3phase 200 V AC	A2002	95.5	13
	A2004	109.5	27
	A2007	132.5	50
1/3phase 200 V AC	AE002	95.5	13
	AE004	109.5	27

- 3G3JX-A4004
- 3G3JX-AE007

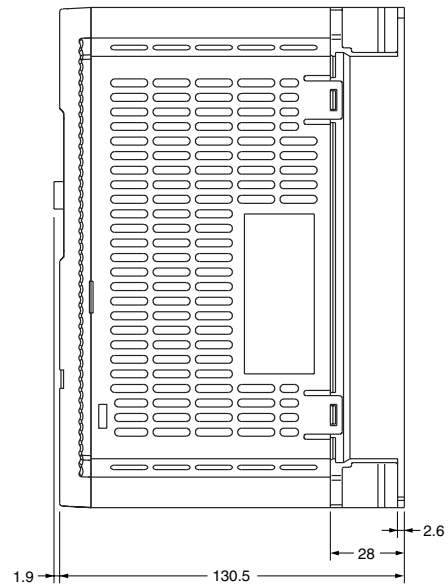
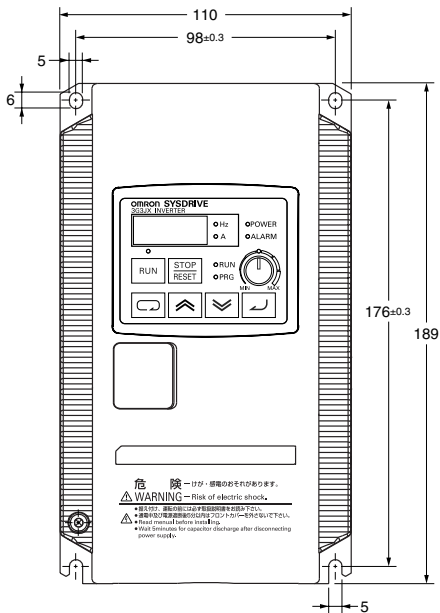

- 3G3JX-A2015
- 3G3JX-A2022
- 3G3JX-A2037
- 3G3JX-A4007
- 3G3JX-A4015
- 3G3JX-A4022
- 3G3JX-A4037
- 3G3JX-AE015
- 3G3JX-AE022

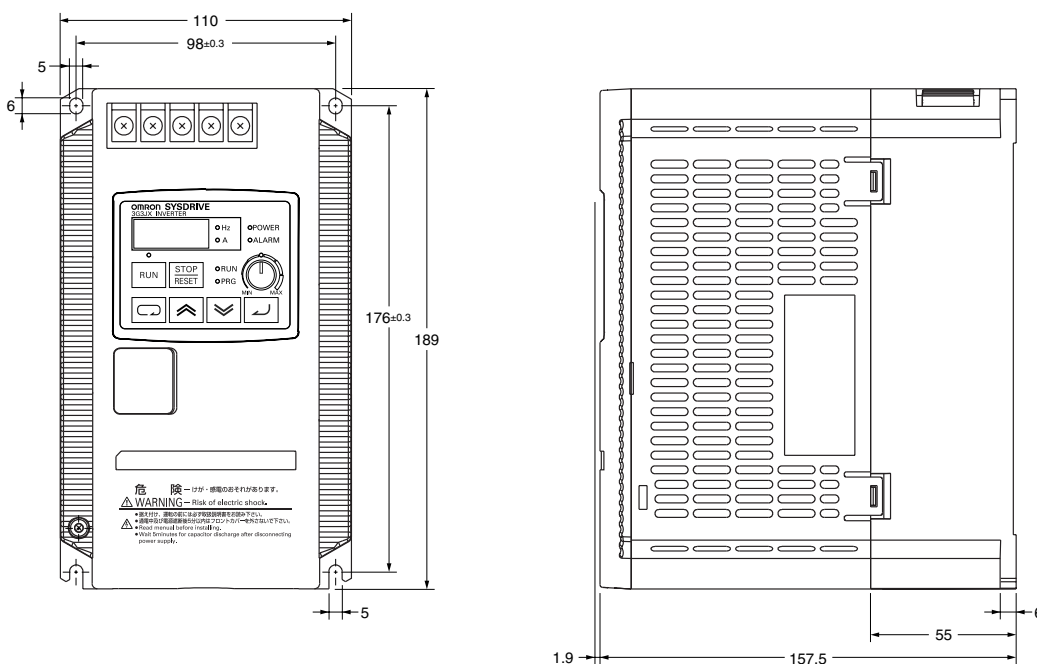

Selection

Features

SYSDRIVE
JX Series

SYSDRIVE
MX Series

SYSDRIVE
RX Series

SYSDRIVE
Option

Overview of
Inverter Selection

Standard Connection Diagram

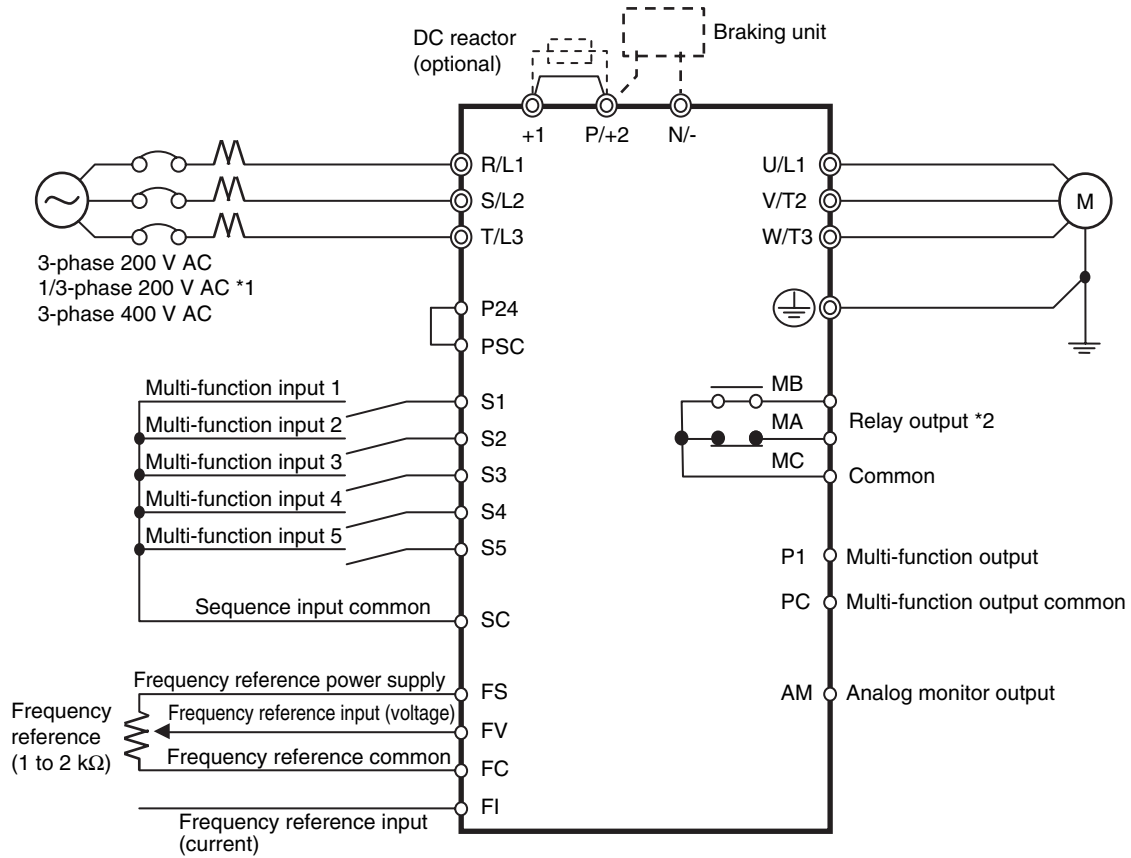

- *1. Connect a single-phase 200-V AC input to terminals R/L1 and S/L2.
- *2. By factory default, MA is set to NC contact, and MB to NO contact in the relay output (MA, MB) selection (C036).

Protective and Diagnostic Functions

●Error Code List

Display on Digital Operator	Name	Description	
<u>E_01</u>	Overcurrent trip	Constant speed	If the motor is restrained, or rapidly accelerated or decelerated, a large current will flow through the Inverter, which will result in breakage. To avoid this, an overcurrent protection circuit works to shut off the Inverter output.
<u>E_02</u>		Deceleration	
<u>E_03</u>		Acceleration	
<u>E_04</u>		Others	
<u>E_05</u>	Overload trip	If an Inverter output current is detected and the motor is overloaded, an electronic thermal inside the Inverter operates to shut off the Inverter output. After a trip occurs, normal operation is restored in 10 seconds by resetting the Inverter.	
<u>E_07</u>	Overvoltage trip	If the incoming voltage and regenerative energy from the motor are too high, a protection circuit works to shut off the Inverter output when the voltage on the converter exceeds the specified level.	
<u>E_08</u>	EEPROM error	Shuts off the output if an error occurs in the EEPROM built into the Inverter due to external noise and abnormal temperature rise. Check the set data again if the <u>E_08</u> error occurs. If the power is shut off during data initialization, an EEPROM error <u>E_08</u> may occur when the power is next turned on. Shut off the power after completing data initialization.	
<u>E_09</u>	Undervoltage trip	Shuts off the output if the incoming voltage drops below the specified level, causing the control circuit not to work properly during a momentary power interruption.	
<u>E_11</u>	CPU error	Shuts off the output if the internal CPU has malfunctioned. If the multi-function output terminal (relay terminal) is set to 05 (alarm), the signal may not be output during the CPU error <u>E_11</u> . In this case, no data is stored in the trip monitor. The same thing could happen if AL (05) is allocated to the relay output terminal. Again, no data is stored.	
<u>E_12</u>	External trip	If an error occurs in the external equipment or devices, the Inverter receives the signal, and the output is shut off. (Available with the external trip function selected)	
<u>E_13</u>	USP trip	Appears if the Inverter is turned on with the RUN command being input. (Available with the USP function selected) If an undervoltage trip <u>E_09</u> occurs with the USP terminal set to ON, the trip, after released by resetting, becomes a USP trip <u>E_13</u> . Reset again to release the trip.	
<u>E_14</u>	Ground fault trip	Shuts off the output if a ground fault between the Inverter output unit and the motor is detected when turning on the power. The ground fault trip <u>E_14</u> cannot be released with the reset input. Shut off the power and check the wiring.	
<u>E_15</u>	Incoming overvoltage trip	Appears if the incoming voltage has remained high for 100 seconds while the Inverter output is stopped.	
<u>E_21</u>	Temperature error	Shuts off the output if the temperature has risen in the main circuit due to malfunction of the cooling fan or other reason.	
<u>E_30</u>	Driver error	Shuts off the output if overcurrent is detected in the main circuit.	
<u>E_35</u>	Thermistor error	While the thermistor input function is used, this detects the resistance of the external thermistor and shuts off the Inverter output.	
<u>E_37</u>	Emergency shutoff	With the emergency shutoff selected (DIP switch on the control board SW8 = ON), this error appears when an emergency shutoff signal is input from input terminal 3.	
<u>E_60</u>	Communications error	Occurs when the communication watchdog timer times out.	

Model Number Explanation

3G3JX-A□□□□

JX-series
Inverter

Maximum Motor Capacity

002	0.2 kW	022	2.2 kW
004	0.4 kW	037	3.7 kW
007	0.75 kW	055	5.5 kW
015	1.5 kW	075	7.5 kW

Voltage Class

2	3-phase 200 V AC
4	3-phase 400 V AC
E	1-/3-phase 200 V AC

Standard Models

Rated voltage	Enclosure rating	Max. applicable motor capacity	Model
3-phase 200 V AC	IP20	0.2 kW	3G3JX-A2002
		0.4 kW	3G3JX-A2004
		0.75 kW	3G3JX-A2007
		1.5 kW	3G3JX-A2015
		2.2 kW	3G3JX-A2022
		3.7 kW	3G3JX-A2037
1/3-phase 200 V AC		0.2 kW	3G3JX-AE002
		0.4 kW	3G3JX-AE004
		0.75 kW	3G3JX-AE007
		1.5 kW	3G3JX-AE015
		2.2 kW	3G3JX-AE022
		3.7 kW	3G3JX-AE037
3-phase 400 V AC		0.4 kW	3G3JX-A4004
		0.75 kW	3G3JX-A4007
	1.5 kW	3G3JX-A4015	
	2.2 kW	3G3JX-A4022	
	3.7 kW	3G3JX-A4037	

International Standards (EC Directives and UL/cUL Standards)

The 3G3JX Inverter meets the EC Directives and UL/cUL standard requirements for worldwide use.

Classification		Applicable standard
EC Directives	EMC Directive	EN61800-3: 2004
	Low-voltage Directive	EN61800-5-1: 2003
UL/cUL Standards		UL508C

MEMO

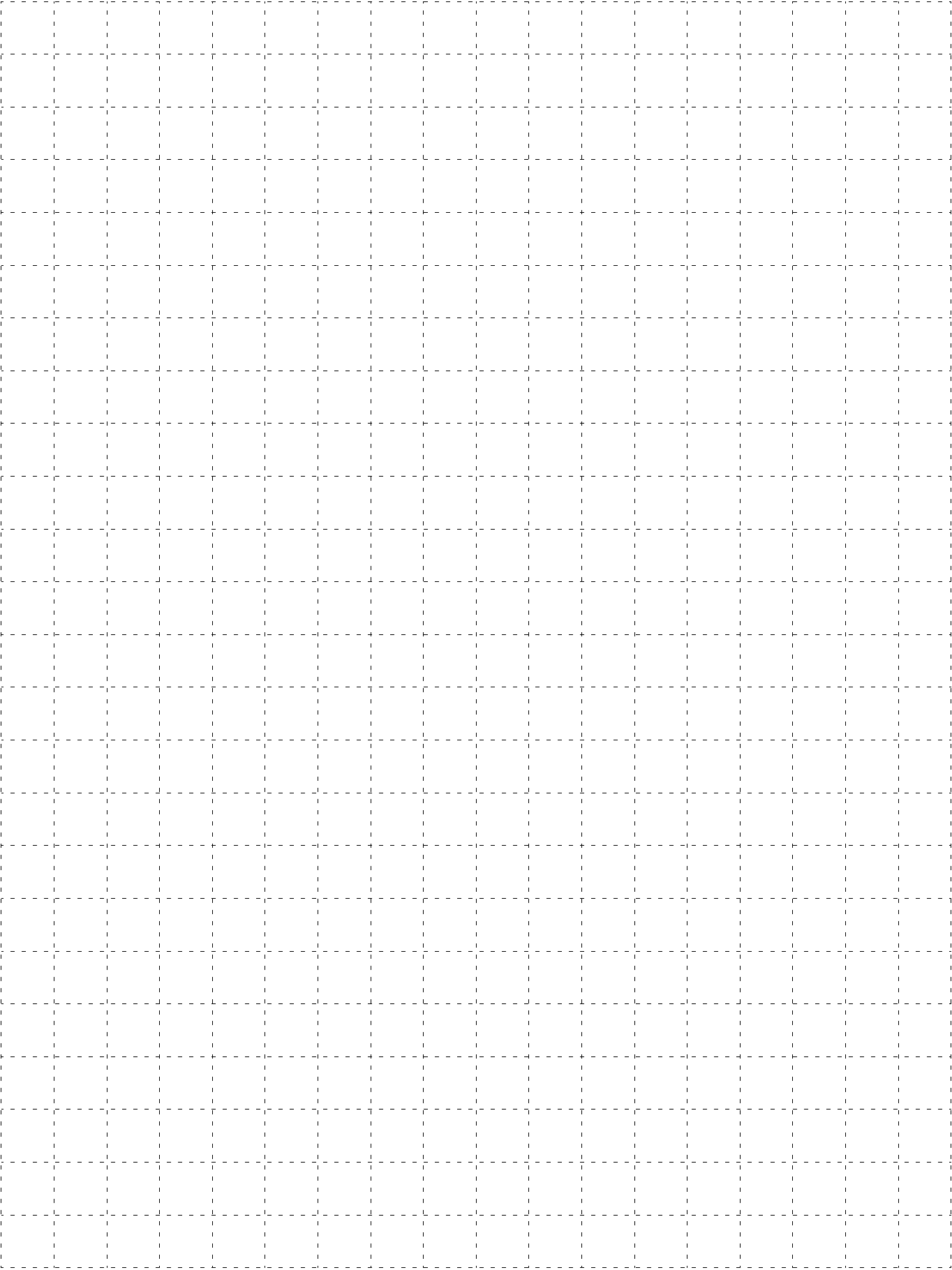

Multi-functional Compact Inverters

SYSDRIVE MX Series





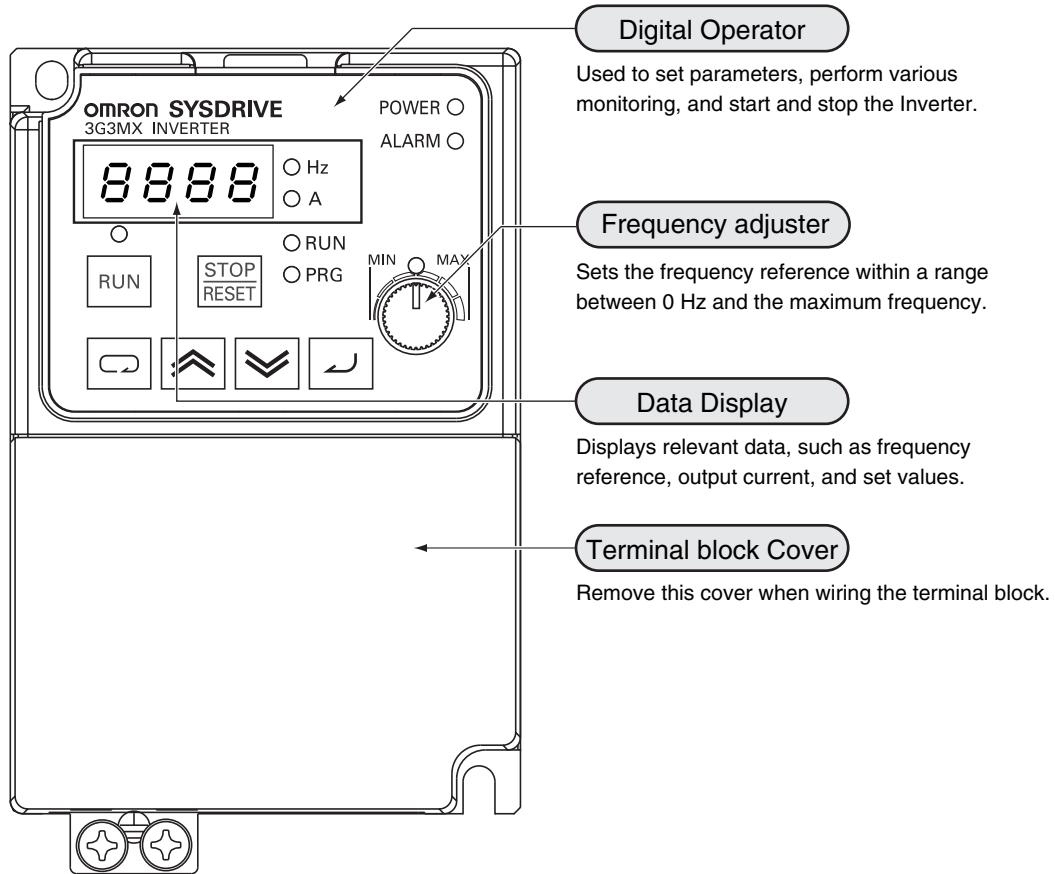

Nomenclature and Functions

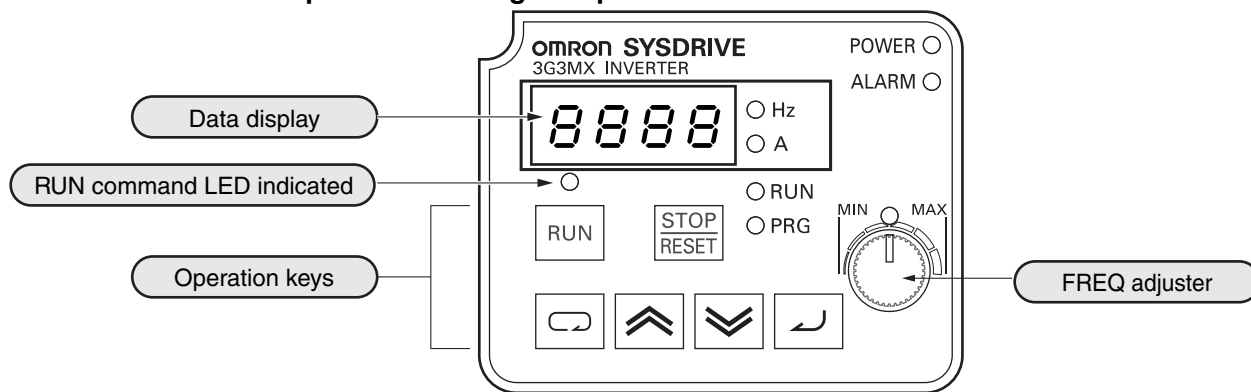
■ Inverter Nomenclature and Functions

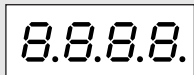
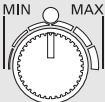

■ Part Names and Descriptions of the Digital Operator



	Name	Description
POWER ○	POWER LED indicator	Lit when the power is supplied to the control circuit.
ALARM ○	ALARM LED indicator	Lit when an Inverter error occurs.
○ RUN	RUN (during RUN) LED indicator	Lit when the Inverter is running.
○ PRG	PROGRAM LED indicator	Lit when the set value of each function is indicated on the data display. Blinks during warning (when the set value is incorrect).
	Data display	Displays relevant data, such as frequency reference, output current, and set values.
○ Hz ○ A	Data display LED indicator	Lit according to the indication on the data display. Hz: Frequency A: Current
	Volume LED indicator	Lit when the frequency reference source is set to the FREQ adjuster.
	FREQ adjuster	Sets a frequency. Available only when the frequency reference source is set to the FREQ adjuster. (Check that the Volume LED indicator is lit.)
○	RUN command LED indicator	Lit when the RUN command is set to the Digital Operator. (The RUN key on the Digital Operator is available for operation.)
	RUN key	Activates the Inverter. Available only when operation via the Digital Operator is selected. (Check that the RUN command LED indicator is lit.)
	STOP/RESET key	Decelerates and stops the Inverter. Functions as a reset key if an Inverter error occurs.
	Mode key	Switches between the monitor mode (d□□□), the basic function mode (F□□□), and the extended function mode (A□□□, b□□□, c□□□, H□□□).
	Enter key	Enters the set value. (To change the set value, be sure to press the Enter key.)
	Increment key	Changes the mode. Also, increases the set value of each function.
	Decrement key	Changes the mode. Also, decreases the set value of each function.

Using Digital Operator

1. Setting the Maximum output frequency

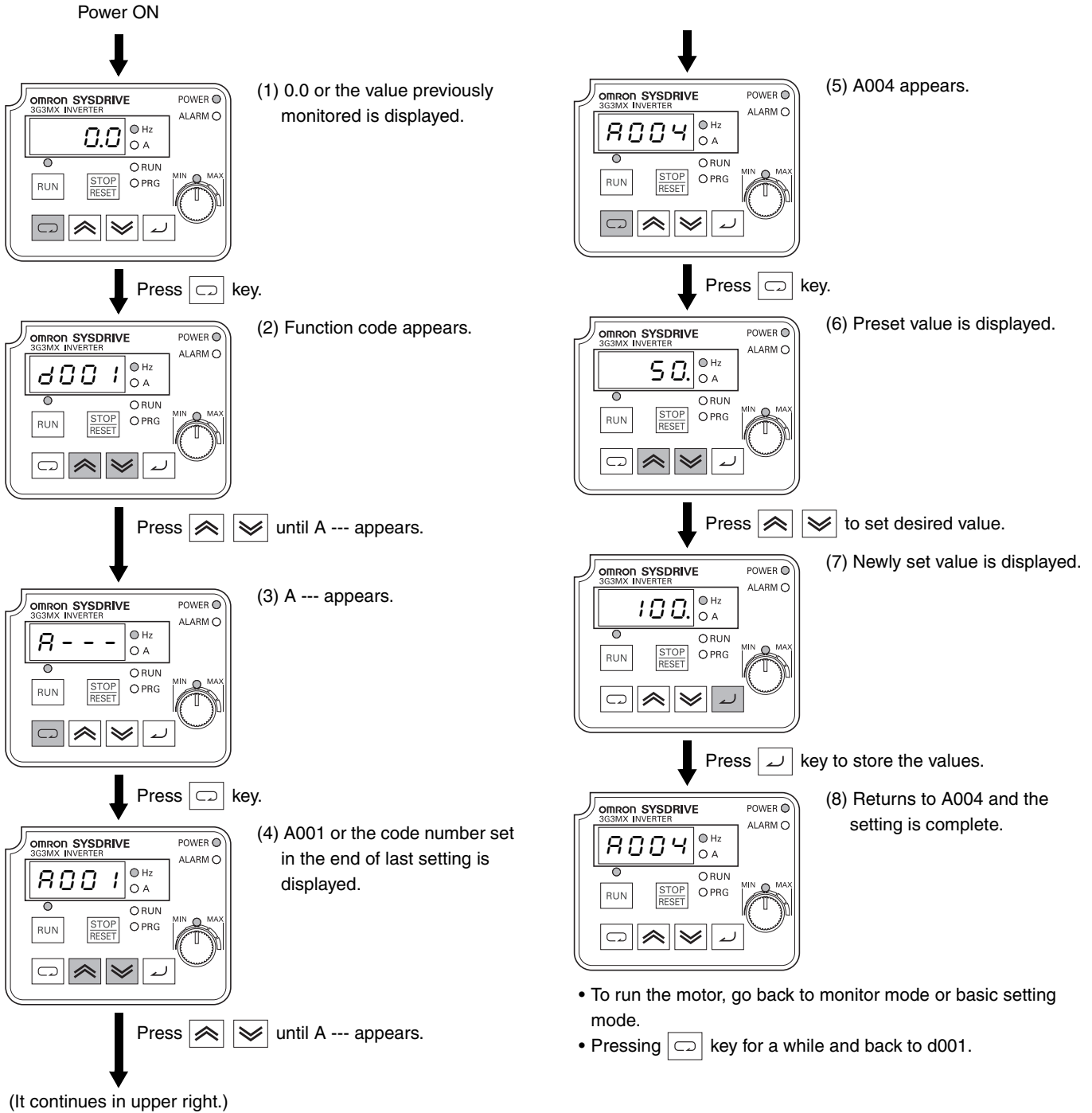

2. Running the motor (by potentiometer)

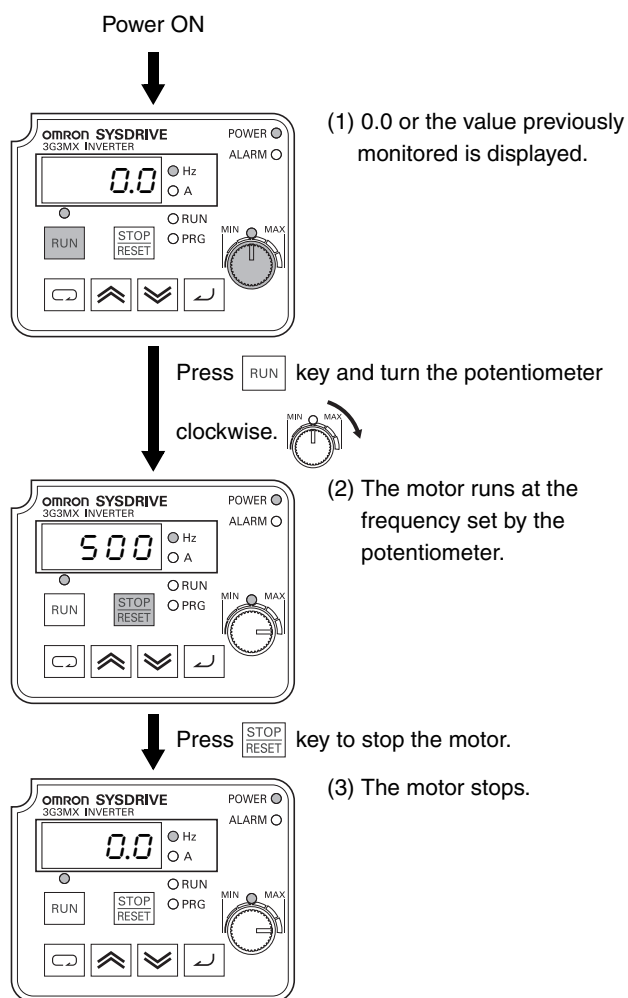

3. Monitoring output current value

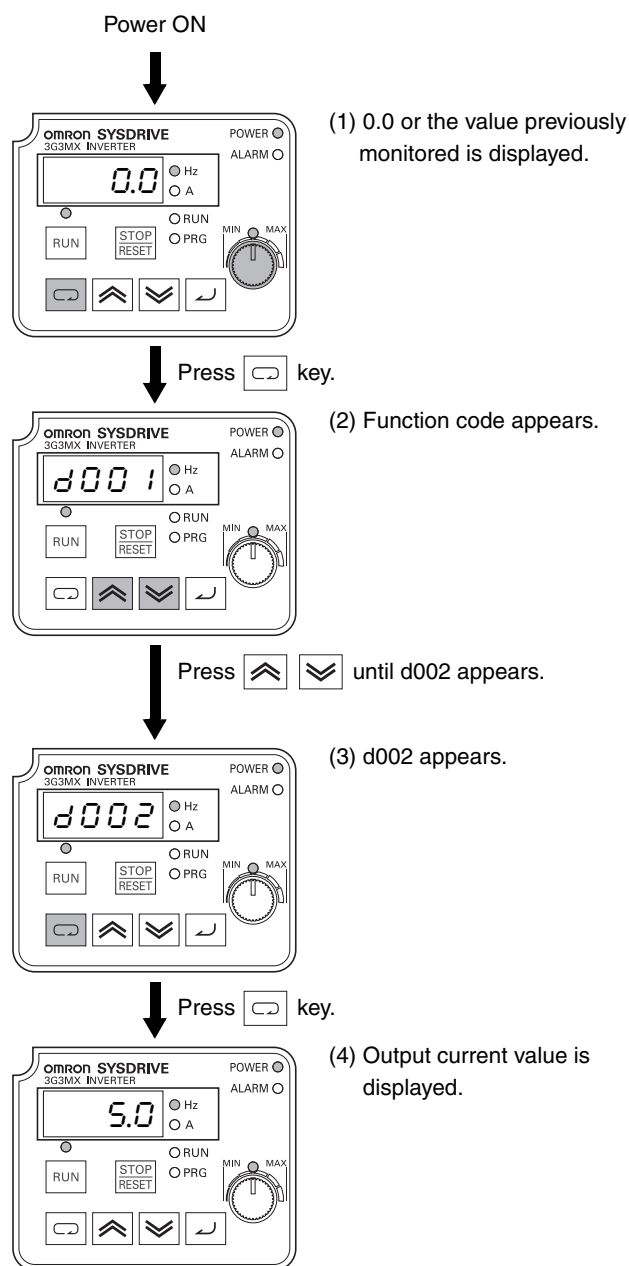

Standard Specification List

●200-V Class

Item Model name (3G3MX-)		3-phase 200-V class							
		A2002	A2004	A2007	A2015	A2022	A2037	A2055	A2075
Applicable motor capacity ¹	kW	0.2	0.4	0.75	1.5	2.2	3.7	5.5	7.5
	HP	1/4	1/2	1	2	3	5	7.5	10
Rated output capacity (kVA)	200 V	0.6	1.0	1.7	2.8	3.8	6.1	8.3	11.1
	220 V	0.6	1.1	1.9	3.0	4.2	6.6	9.1	12.2
Rated input voltage		3-phase (3-wire) 200 to 240 V ±10%, 50/60 Hz ±5%							
Rated output voltage ²		3-phase 200 to 240 V AC (according to the incoming voltage)							
Rated output current (A)		1.6	3.0	5.0	8.0	11.0	17.5	24.0	32.0
Weight (kg)		0.7	0.85	0.9	1.8	1.8	1.8	3.5	3.5
Cooling method		Self-cooling			Forced-air-cooling				
Braking torque	At short-time deceleration ³ At capacitor feedback	Approx. 50%			Approx. 20% to 40%			Approx. 20%	
	For mounting discharge resistance	Approx. 150%		Approx. 100%		Approx. 80%			
	Minimum connection resistance (Ω)	100		50		35		17	

●400-V Class

Item Model name (3G3MX-)		3-phase 400-V class							
		A4004	A4007	A4015	A4022	A4037	A4055	A4075	
Applicable motor capacity ¹	kW	0.4	0.75	1.5	2.2	3.7	5.5	7.5	
	HP	1/2	1	2	3	5	7.5	10	
Rated output capacity (kVA)	400 V	1.0	1.7	2.6	3.8	6.0	9.0	11.1	
	440 V	1.1	1.9	2.8	4.1	6.5	9.9	12.1	
Rated input voltage		3-phase (3-wire) 380 to 480 V ±10%, 50/60 Hz ±5%							
Rated output voltage ²		3-phase 380 to 480 V AC (according to the incoming voltage)							
Rated output current (A)		1.5	2.5	3.8	5.5	8.6	13.0	16.0	
Weight (kg)		1.3	1.7	1.8	1.8	1.8	3.5		
Cooling method		Self-cooling			Forced-air-cooling				
Braking torque	At short-time deceleration ³ At capacitor feedback	Approx. 50%			Approx. 20% to 40%			Approx. 20%	
	For mounting discharge resistance	Approx. 150%	Approx. 100%		Approx. 80%				
	Minimum connection resistance (Ω)	180			100		70		

●Single/Three-phase 200-V Class

Item Model name (3G3MX-)		1/3-phase 200-V class				
		AE002	AE004	AE007	AE015	AE022
Applicable motor capacity ¹	kW	0.2	0.4	0.75	1.5	2.2
	HP	1/4	1/2	1	2	3
Rated output capacity (kVA)	200 V	0.5	0.8	1.3	2.7	3.8
	240 V	0.6	1.2	2.0	3.3	4.5
Rated input voltage		1/3-phase 200 V -10% to 240 V +10%, 50/60 Hz ±5%				
Rated output voltage ²		3-phase 200 to 240 V (Cannot output the voltage with abnormal incoming voltage.)				
Rated output current (A)		1.6	2.6	4.0	8.0	11.0
Weight (kg)		0.7	0.85	0.9	1.8	1.8
Cooling method		Self-cooling			Forced-air-cooling	
Braking torque	At short-time deceleration ³ At capacitor feedback	Approx. 50%			Approx. 20% to 40%	
	For mounting discharge resistance	Approx. 150%		Approx. 100%		Approx. 80%
	Minimum connection resistance (Ω)	100		50		35

Common Specifications

Item		Specifications
Enclosure rating *4		Semi-closed (IP20)
Control	Control Method	Phase-to-phase sinusoidal modulation PWM
	Output frequency range *5	0.5 to 400 Hz
	Frequency precision *6	Digital command: ±0.01% of the max. frequency Analog command: ±0.2% of the max. frequency (25°C ±10°C)
	Frequency setting resolution	Digital setting: 0.1 Hz Analog setting: Max. frequency/1000
	Voltage/Frequency characteristics	V/f characteristics (constant/reduced torque)
	Overload current rating	150% for 1 min
	Acceleration/Deceleration time	0.01 to 3000 s (line, S-shape curve), 2nd acceleration/deceleration setting available
	Start torque	200% min./1 Hz
	Carrier frequency modification range	2.0 to 14.0 kHz
	DC injection braking	Starts at a frequency lower than that in deceleration via the STOP command, or via an external input. (Level and time settable.)
Protective Functions		Overcurrent, overvoltage, undervoltage, electronic thermal, temperature error, ground-fault overcurrent at power-on state, overload limit, incoming overvoltage, external trip, memory error, CPU error, USP error, internal communication error, BRD error, overvoltage protection during deceleration, overcurrent suppression
Input signal	Multi-function input	FW (forward), RV (reverse), CF1 to CF4 (multi-step speed), RS (reset), AT (current input selection), USP (USP function), EXT (external trip), OPE (forced OPE mode), STA (3-wire startup), STP (3-wire stop), F/R (3-wire forward/reverse), FRS (free run stop), JG (jogging), 2CH (2-step acceleration/deceleration), DB (external DC injection braking), SET (2nd function), UP (remote operation/accelerate), DWN (remote operation/decelerate), PID (PID selection), PIDC (PID deviation reset), PTC (thermistor input), UDC (data clear of UP/DWN function), SFT (soft lock), ADD (frequency addition), F-TM (forced terminal block), RDY (operation ready), SP-SET (special setting)
Output signal	Multi-function output	RUN (signal during operation), FA1 (frequency arrival signal), FA2 (frequency arrival signal), OL (overload warning signal), OD (PID excess deviation signal), AL (alarm signal), ODC (communication option disconnected), FBV (PID FB status output), NDc (Network error), LOG (Logic operation output)
	Frequency monitor	Analog meter (0 to 10 V DC, 1 mA max.), Frequency/Current signals are selectable via the analog output terminal.
	Relay output	The relay (SPDT contact) outputs signals corresponding to the multi-function output.
Other functions		AVR function, V/f characteristic selection, line acceleration/deceleration, upper/lower limit, 16-step speeds, starting frequency adjustment, jogging operation, carrier frequency adjustment, PID control, frequency jump, analog gain/bias adjustment, S-shape acceleration/deceleration, electronic thermal characteristics/level adjustment, retry function, automatic torque boost, trip monitor, soft lock function, frequency conversion display, USP function, 2nd control function, motor rotation speed UP/DOWN, fan ON/OFF function
General specifications	Ambient temperature	-10°C to 40°C (Carrier frequency: 5 kHz max.) -10°C to 50°C (Both the carrier frequency and output current need to be reduced)
	Ambient storage temperature	-20°C to 65°C (short-time temperature during transport)
	Humidity	20% to 90% RH
	Vibration	5.9 m/s ² (0.6G), 10 to 55 Hz (Complies with the test method specified in JIS C0040 (1999).)
	Location	At a maximum altitude of 1,000 m; indoors (without corrosive gases or dust)
	Applicable standard	Complies with UL, cUL, CE standards. (Insulation distance)
Options		Noise filter, AC/DC reactors, regenerative braking unit and resistor, etc.

- *1. The applicable motor is a 3-phase standard motor. For using any other type, be sure that the rated current does not exceed that of the Inverter.
- *2. Output voltage decreases according to the level of the power supply voltage.
- *3. The braking torque at the time of capacitor feedback is an average deceleration torque at the shortest deceleration (when it stops from 50 Hz), not a continuous regeneration torque. Also, the average deceleration torque varies depending on the motor loss. The value is reduced in operation over 50 Hz. Note that no regenerative braking circuit is built into the Inverter. If you need a larger regenerative torque, use the optionally available regenerative braking unit and resistor. The regenerative braking unit should be used only for short-time regeneration.
- *4. Protection method complies with JEM 1030.
- *5. To operate the motor at over 50/60 Hz, contact the motor manufacturer to find out the maximum allowable revolution.
- *6. For motor stabilization, the output frequency may exceed the maximum frequency set in A004 (A204) by 2 Hz max.

■ Terminal Block Specifications

● Terminal Block Position

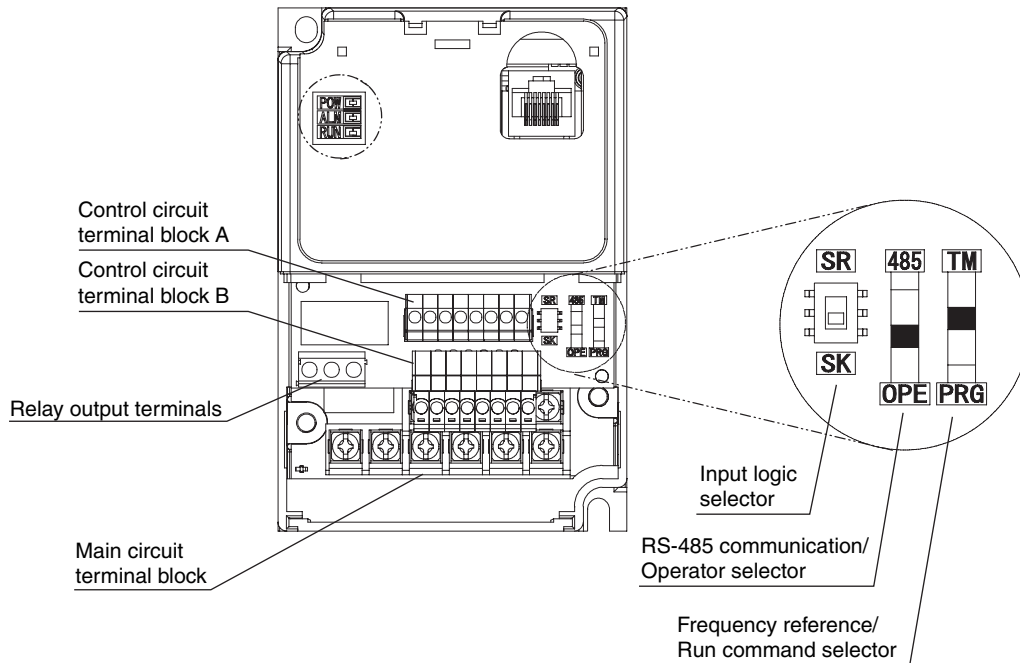

Note. This illustration shows the terminal block with the front cover removed

● Specifications of Main Circuit Terminals

Terminal Arrangement
3G3MX-A2002 to A2007
3G3MX-AE002 to AE004

Terminal Arrangement
3G3MX-A2015 to A2037
3G3MX-A4004 to A4037
3G3MX-AE007 to AE022

Terminal Arrangement
3G3MX-A2055 to A2075
3G3MX-A4055 to A4075

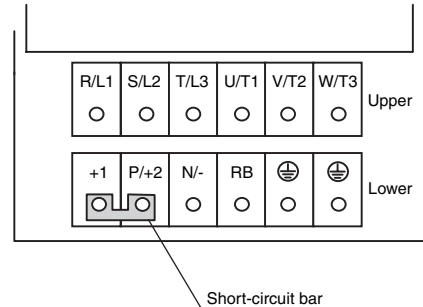
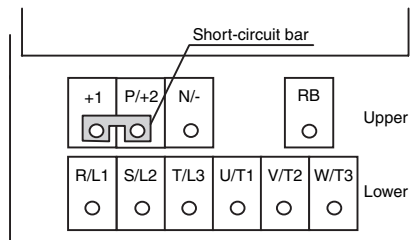
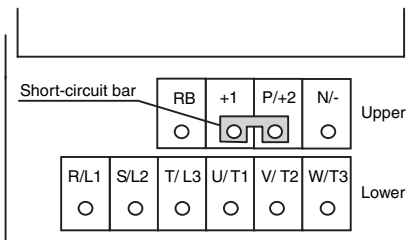

Terminal symbol	Terminal name	Function	Connection example
R/L1, S/L2, T/L3	Main power supply input terminal	Connect the input power supply.	<p>Do not remove the short-circuit bar between +1 and P/+2 when a DC reactor is not connected.</p>
U/T1, V/T2, W/T3	Inverter output terminal	Connect to the motor.	
+1, P/+2	External DC reactor terminal	Normally connected by the short-circuit bar. Remove the short-circuit bar between +1 and P/+2 when a DC reactor is connected.	
P/+2, RB	External braking resistor connection terminal	Connect the optional braking resistor. (If a braking torque is required)	
P/+2, N/-	Regenerative braking unit connection terminal	Connect optional regenerative braking units. (If a braking torque is required) (if insufficient with only the built-in braking circuit)	
⊥	Ground terminal	Ground (Connect to ground to prevent electric shock and reduce noise.)	

● Control Circuit Terminal Specifications

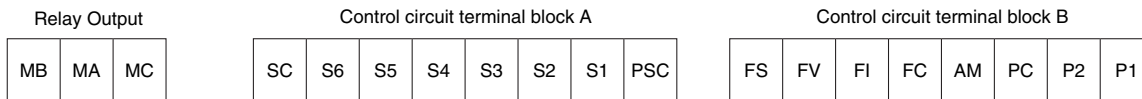

	Terminal symbol	Terminal name and function	Default setting	Specifications
Input signal	PSC	External power supply terminal for input signal (input) ...At sink logic Internal power supply output terminal for input signal (output) ...At source logic	---	24 V DC ±10% 30 mA max. 24 V DC ±10% 100 mA max.
	S1	Multi-function input S1 to S6 Select 6 functions among the 27 functions and allocate them to from terminals S1 to S6.	Forward/Stop	Contact input Close: ON (Start) Open: OFF (Stop) Minimum ON time: 12 ms min.
	S2		Reverse/Stop	
	S3		Fault reset	
	S4		External trip	
	S5		Multi-step speed reference 1	
	S6		Multi-step speed reference 2	
	SC	Input signal common	---	
Monitor signal	AM	Analog frequency monitor/Analog output current monitor	Analog frequency monitor	
	SC	Monitor common	---	
Frequency reference input	FS	Frequency reference power supply	---	10 V DC 10 mA max.
	FV	Voltage frequency reference signal	---	0-10 V DC Input impedance 10 Ω
	FI	Current frequency reference signal	---	DC 4-20 mA Input impedance 250 Ω
	FC	Frequency reference common	---	
Output signal	P1	Multi-function Output Terminal Select 2 functions of the Inverter status and allocate them to terminals P1 and P2.	Frequency arrival signal at a constant speed	27 V DC 50 mA max.
	P2		Signal during RUN	
	PC	Output signal common	---	
Relay output signal	MA		Factory default relay settings Under normal operation: MA-MC Close Under abnormal operation or power shutdown: MA-MC Open	
	MB			
	MC			

● Mode Selector

For the mounting position of each selector, refer to page 30.

<Input Logic Selector>

Available to switch the input logic (source or sink) in the multi-function input terminal circuit.

Symbol	Name	Status	Description
SR/SK	Input logic selector	SR	Source logic
		SK [Default]	Sink logic

<RS-485 Communication/Operator Selector>

Select the mode according to the option connected to the communications connector.

When using the 3G3AX-OP01 supplied with the Inverter, it is available regardless of the switch condition

Symbol	Name	Status	Description
485/OPE	RS-485 communication/ operator selector	485	ModBus communication
		OPE [Default]	Digital Operator (Option: 3G3AX-OP01)

<Frequency Reference/RUN Command Source Selector>

Switches the source for frequency reference and RUN command of the Inverter.

Symbol	Name	Status	Description
TM/PRG	Frequency reference/ RUN command source selector	TM	Control terminal block (terminals): The set values in A001 and A002 are invalid. Frequency reference: Analog external input (FV, FI) RUN command: Operation using the FW or RV terminal 00 (FW) or 01 (RV) must be allocated to the multi-function input terminals.
		PRG [Default]	Digital Operator setting (depends on the set values in A001 and A002.) Frequency reference: Adjuster (factory default) Available to change with the frequency reference selection (A001). RUN command: Digital Operator Available to change with the RUN command selection (A002).

Dimensions

- 3G3MX-A2002
- 3G3MX-A2004
- 3G3MX-A2007
- 3G3MX-AE002
- 3G3MX-AE004

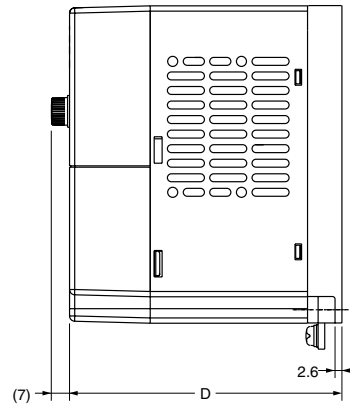
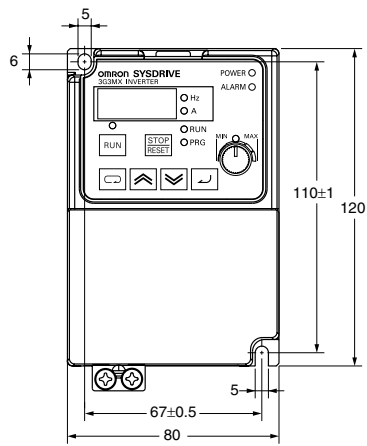

Rated voltage	Model 3G3MX-	Dimensions (mm)
		D
3phase 200 V AC	A2002	103
	A2004	117
	A2007	140
1/3phase 200 V AC	AE002	103
	AE004	117

- 3G3MX-A4004
- 3G3MX-AE007

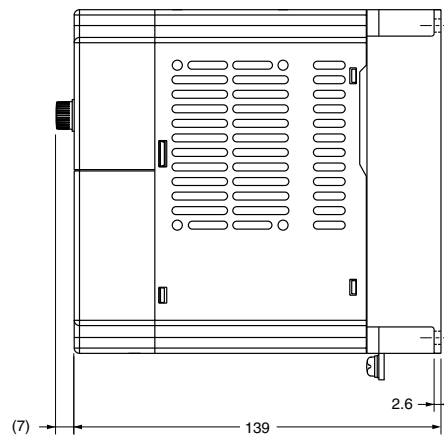
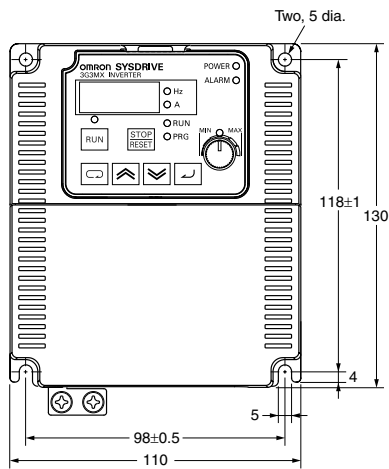

- 3G3MX-A2015
- 3G3MX-A2022
- 3G3MX-A2037
- 3G3MX-A4007
- 3G3MX-A4015
- 3G3MX-A4022
- 3G3MX-A4037
- 3G3MX-AE015
- 3G3MX-AE022

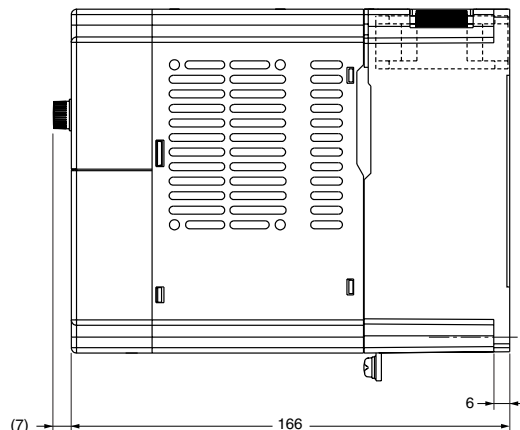
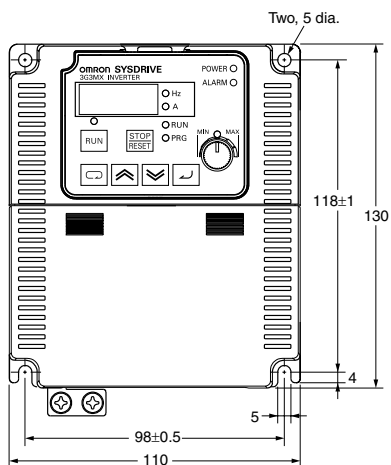

- 3G3MX-A2055
- 3G3MX-A2075
- 3G3MX-A4055
- 3G3MX-A4075

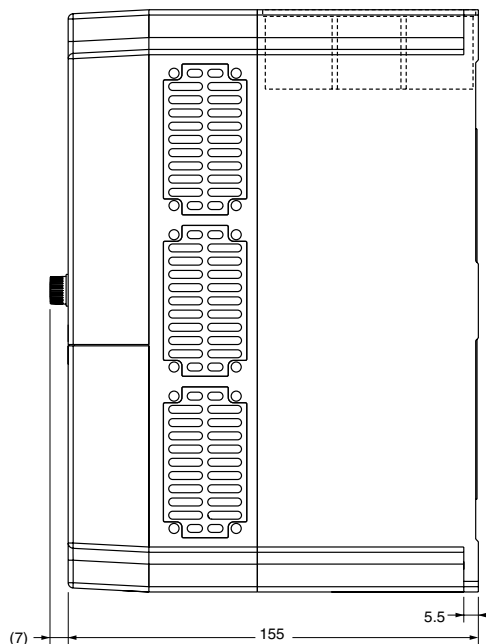
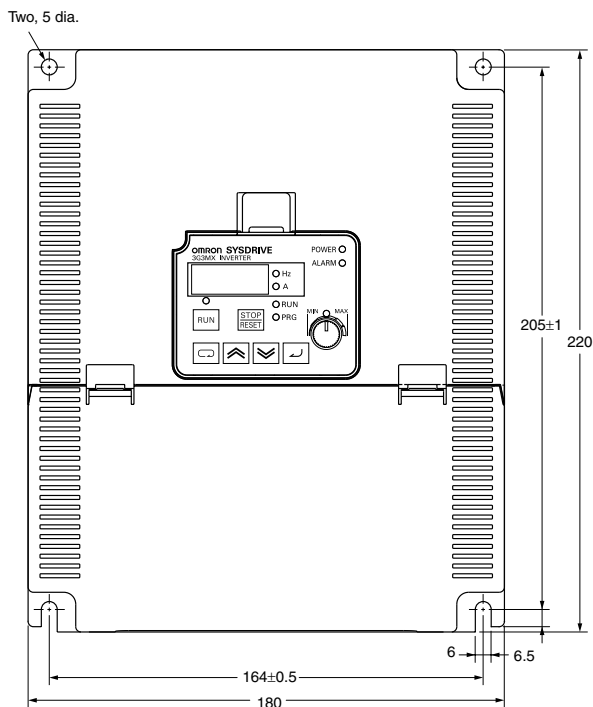

Selection

Features

SYSDRIVE
JX Series

SYSDRIVE
MX Series

SYSDRIVE
RX Series

SYSDRIVE
Option

Overview of
Inverter Selection

Standard Connection Diagram

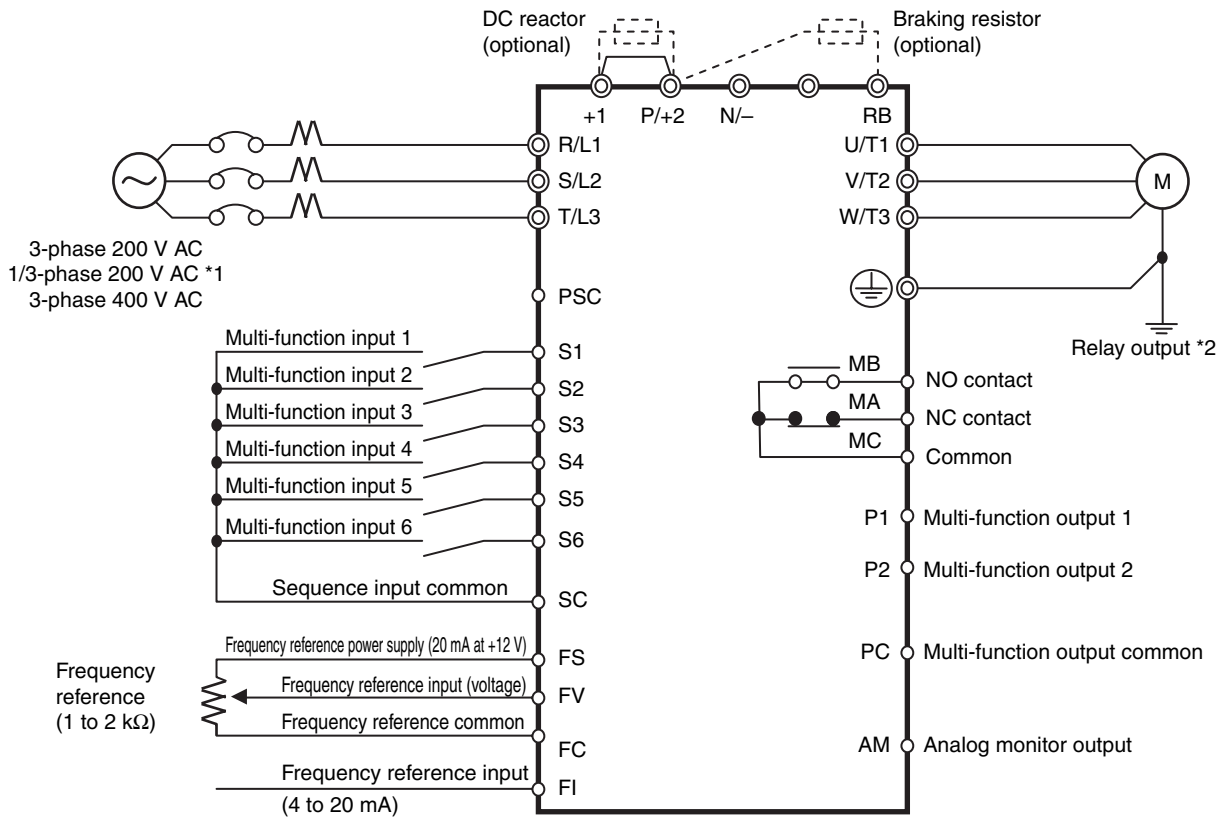

*1. Connect a single-phase 200-V AC input to terminals R/L1 and S/L2.

*2. By factory default, MA is set to NC contact, and MB to NO contact in the relay output (MA, MB) selection (C036).

Protective and Diagnostic Functions

●Error Code List

Display on Digital Operator	Name	Description	
$\boxed{E\ 01}$	Overcurrent trip	Constant speed	If the motor is restrained or rapidly accelerated or decelerated, a large current will flow through the Inverter, which will result in breakage. To avoid this, an overcurrent protection circuit works to shut off the Inverter output.
$\boxed{E\ 02}$		Deceleration	
$\boxed{E\ 03}$		Acceleration	
$\boxed{E\ 04}$		Others	
$\boxed{E\ 05}$	Overload trip *1	If an Inverter output current is detected and the motor is overloaded, an electronic thermal inside the Inverter works to shut off the Inverter output.	
$\boxed{E\ 06}$	Braking resistor overload trip	When the usage rate of the braking resistor is exceeded, this function detects overvoltage due to operation stop of the control circuit and shuts off the Inverter output.	
$\boxed{E\ 07}$	Overvoltage trip	If the incoming voltage and regenerative energy from the motor are too high, a protection circuit works to shut off the Inverter output when the voltage on the converter exceeds the specified level.	
$\boxed{E\ 08}$	EEPROM error *2 *3	Shuts off the output if an error occurs in the EEPROM built into the Inverter due to external noise and abnormal temperature rise.	
$\boxed{E\ 09}$	Undervoltage trip	Shuts off the output if the incoming voltage drops below the specified level, causing the control circuit not to work properly during a momentary power interruption.	
$\boxed{E\ 11}$	CPU error *6	Shuts off the output if the internal CPU has worked erroneously or abnormally.	
$\boxed{E\ 22}$			
$\boxed{E\ 12}$	External trip	If an error occurs in the external equipment or devices, the Inverter receives the signal, and the output is shut off. (Available with the external trip function selected)	
$\boxed{E\ 13}$	USP trip *4	Appears if the Inverter is turned on with the RUN command being input. (Available with the USP function selected)	
$\boxed{E\ 14}$	Ground fault trip *5	Shuts off the output if a ground fault between the Inverter output unit and the motor is detected when turning on the power.	
$\boxed{E\ 15}$	Incoming overvoltage trip	Appears if the incoming voltage has remained high for 100 seconds while the Inverter output is stopped.	
$\boxed{E\ 21}$	Temperature error	Shuts off the output if the temperature has risen in the main circuit due to malfunction of the cooling fan or other reason.	
$\boxed{E\ 23}$	Gate array error	Displayed when a fault is detected in communication behavior between the built-in CPU and the gate array.	
$\boxed{E\ 35}$	Thermistor error (Available when the thermistor trip function is used)	Detects the resistance of the external thermistor and shuts off the Inverter output.	

*1. After a trip occurs, normal operation is restored in 10 seconds by resetting.

*2. Check the set data again if the EEPROM error $\boxed{E\ 08}$ occurs.

*3. If the power is shut off during data initialization, an EEPROM error $\boxed{E\ 08}$ may occur when the power is next turned on. Shut off the power after completing data initialization or copying.

*4. If an undervoltage trip $\boxed{E\ 09}$ occurs with the USP terminal set to ON, the trip, after released by resetting, becomes a USP error $\boxed{E\ 13}$. Reset again to release the trip.

*5. The ground fault trip $\boxed{E\ 14}$ cannot be released with the reset input. Shut off the power and check the wiring.

*6. If the multi-function output (relay output) is set to 05 (alarm), the signal may not be output during the CPU error $\boxed{E\ 22}$. In this case, no data is stored in the trip monitor.

Model Number Explanation

3G3MX - A □ □ □ □

MX-series
Inverter

Maximum Motor Capacity

002	0.2 kW	022	2.2 kW
004	0.4 kW	037	3.7 kW
007	0.75 kW	055	5.5 kW
015	1.5 kW	075	7.5 kW

Voltage Class

2	3-phase 200 V AC
4	3-phase 400 V AC
E	1-/3-phase 200 V AC

Standard Models

Rated voltage	Enclosure rating	Max. applicable motor capacity	Model
3-phase 200 V AC	IP20	0.2 kW	3G3MX-A2002
		0.4 kW	3G3MX-A2004
		0.75 kW	3G3MX-A2007
		1.5 kW	3G3MX-A2015
		2.2 kW	3G3MX-A2022
		3.7 kW	3G3MX-A2037
		5.5 kW	3G3MX-A2055
7.5 kW		3G3MX-A2075	
1/3-phase 200 V AC		0.2 kW	3G3MX-AE002
		0.4 kW	3G3MX-AE004
		0.75 kW	3G3MX-AE007
		1.5 kW	3G3MX-AE015
		2.2 kW	3G3MX-AE022
3-phase 400 V AC		0.4 kW	3G3MX-A4004
	0.75 kW	3G3MX-A4007	
	1.5 kW	3G3MX-A4015	
	2.2 kW	3G3MX-A4022	
	3.7 kW	3G3MX-A4037	
	5.5 kW	3G3MX-A4055	
	7.5 kW	3G3MX-A4075	

International Standards (EC Directives and UL/cUL Standards)

The 3G3MX Inverter meets the EC Directives and UL/cUL standard requirements for worldwide use.

Classification		Applicable standard
EC Directives	EMC Directive	EN61800-3: 2004
	Low-voltage Directive	EN61800-5-1: 2003
UL/cUL Standards		UL508C

MEMO

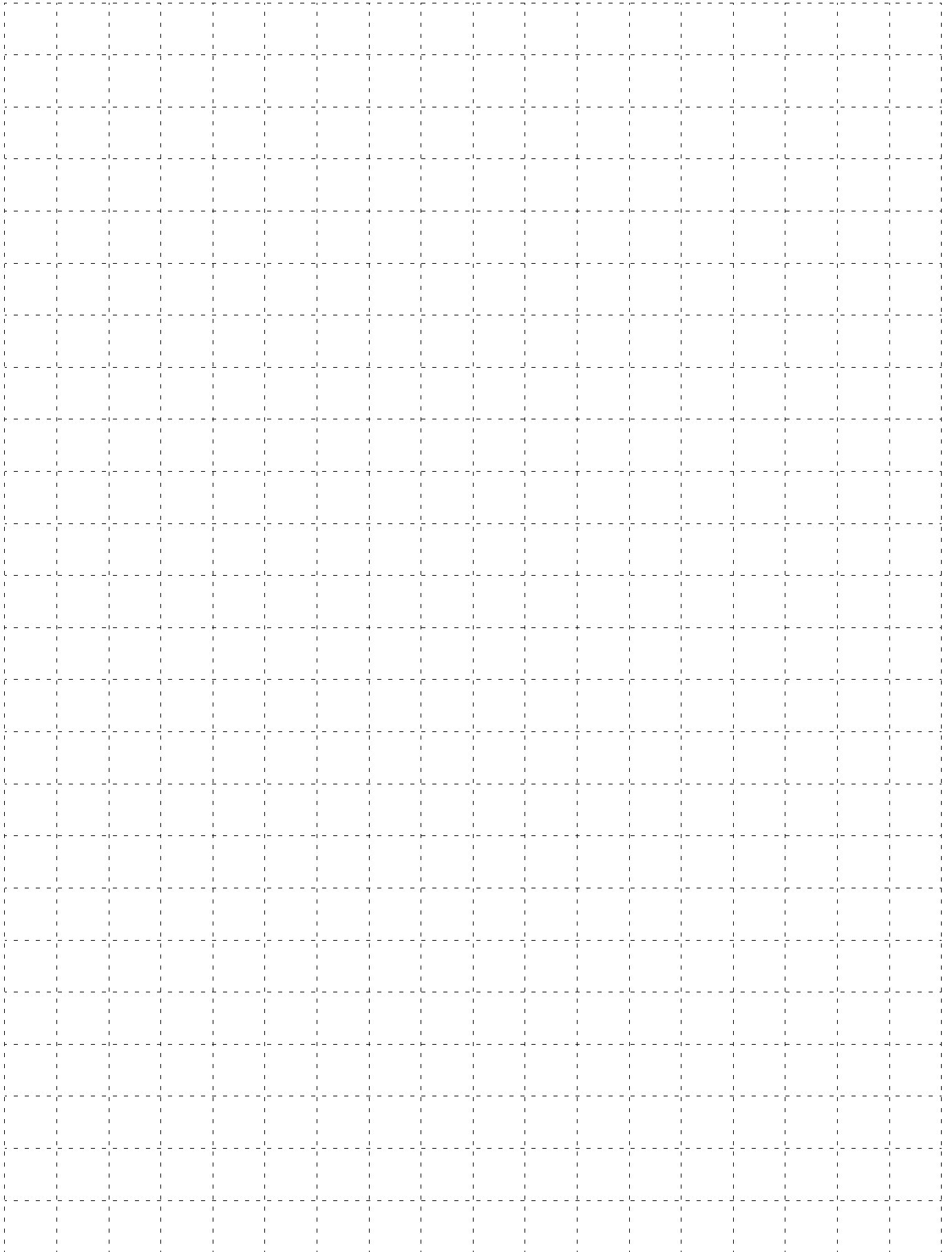

Advanced General-purpose Inverters

SYSDRIVE RX Series

Nomenclature and Functions

■ Inverter Nomenclature and Functions

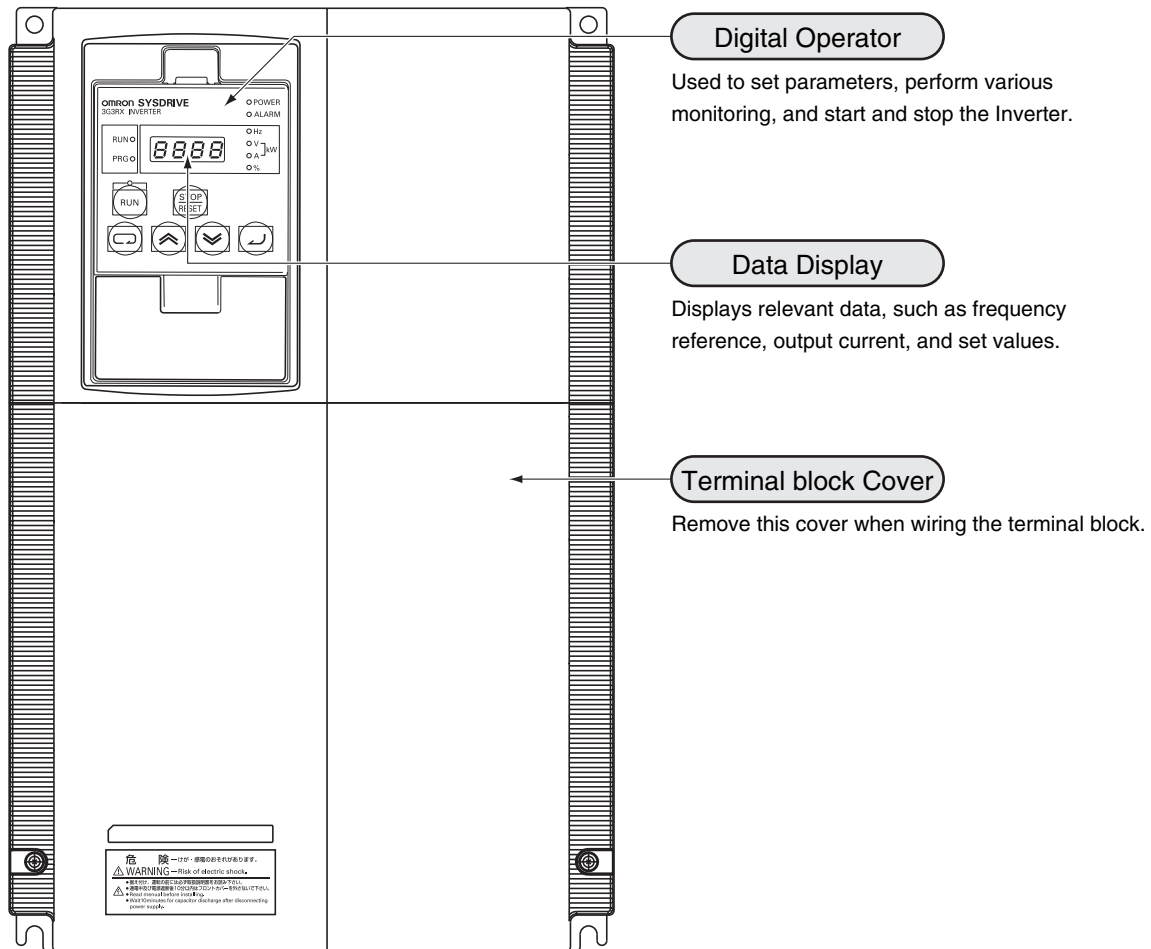

■ Part Names and Descriptions of the Digital Operator

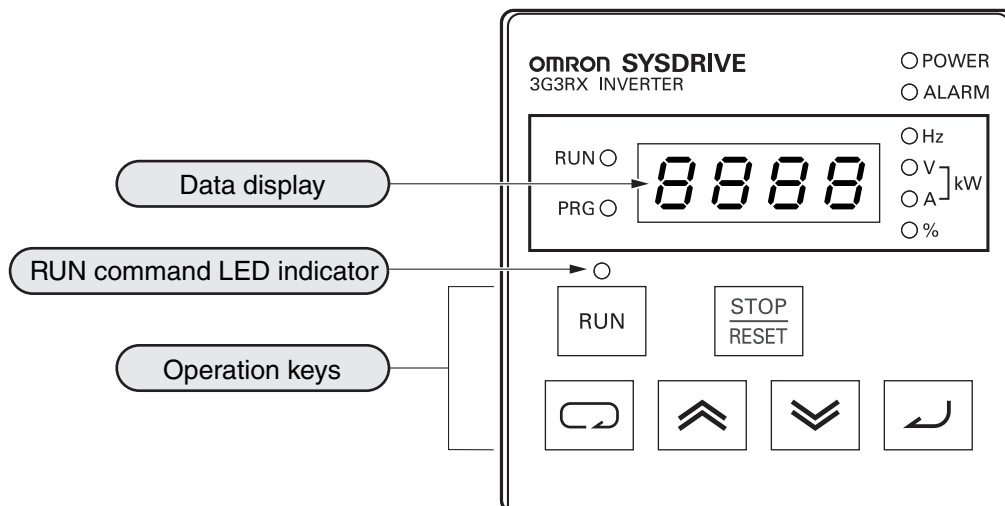

	Name	Function
<input type="radio"/> POWER	POWER LED indicator	Lit when the power is supplied to the control circuit.
<input type="radio"/> ALARM	ALARM LED indicator	Lit when an Inverter error occurs.
RUN <input type="radio"/>	RUN (during RUN) LED indicator	Lit when the Inverter is running.
PRG <input type="radio"/>	PROGRAM LED indicator	Lit when the set value of each function is indicated on the data display. Blinks during warning (when the set value is incorrect).
	Data display	Displays relevant data, such as frequency reference, output current, and set values.
<input type="radio"/> Hz <input type="radio"/> V <input type="radio"/> A <input type="radio"/> % } kW	Data display LED indicator	Lit according to the indication on the data display. Hz: Frequency V: Voltage A: Current kW: Power %: Ratio
<input type="radio"/>	RUN command LED indicator	Lit when the RUN command is set to the Digital Operator. (The RUN key on the Digital Operator is available for operation)
	RUN key	Activates the Inverter. Available only when operation via the Digital Operator is selected. (Check that the RUN command LED indicator is lit.)
	STOP/RESET key	Decelerates and stops the Inverter. Functions as a reset key if an Inverter error occurs.
	Mode key	Switches between: the monitor mode (d□□□), the basic function mode (F□□□), and the extended function mode (A□□□, b□□□, c□□□, H□□□).
	Enter key	Enters the set value. (To change the set value, be sure to press the Enter key.)
	Increment key	Changes the mode. Also, increases the set value of each function.
	Decrement key	Changes the mode. Also, decreases the set value of each function.

Using Digital Operator

■ Setting output frequency

Power ON

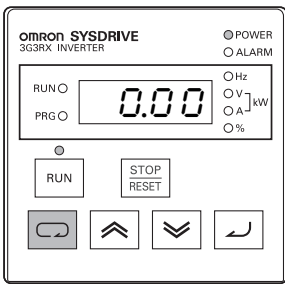

(1) 0.0 or the value previously monitored is displayed.

Press key.

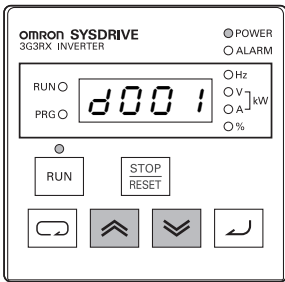

(2) Function code appears.

Press until F001 appears.

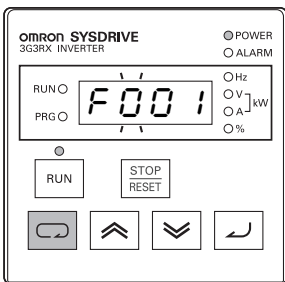

(3) F001 appears.

Press key.

(It continues in upper right.)

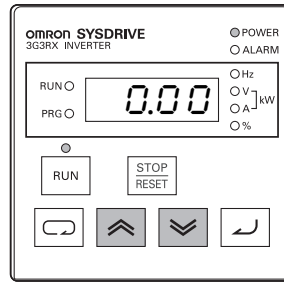

(4) Preset value is displayed.

Press to set desired value.

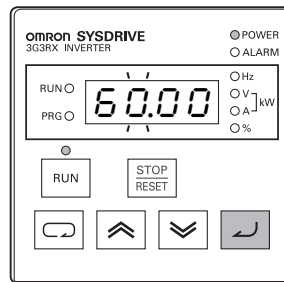

(5) Newly set value is displayed.

Press key to store the value.

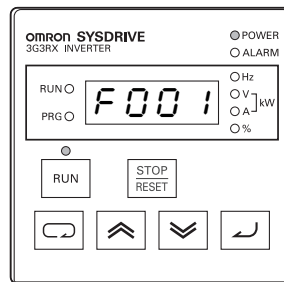

(6) Set end. (Back to F001)

■ Operation Example for Basic Display (factory default: "b037 = 04")

- Displays the limited basic parameters.

Monitor mode: All
 Function mode: 4 parameters
 Extended function mode: 20 parameters

- Other parameters than those mentioned above are not displayed. To display all parameters, select "Complete display 'b037 = 00'".

● Parameters to be Displayed and Arrangement

No.	Display code	Item
1	d001 to d104	Monitor display
2	F001	Output frequency setting
3	F002	Acceleration time 1
4	F003	Deceleration time 1
5	F004	Digital Operator rotation direction Selection (RUN direction selection)
6	A001	Frequency reference selection
7	A002	RUN command selection
8	A003	Base frequency
9	A004	Maximum frequency
10	A005	FV/FI terminal selection
11	A020	Multi-step speed reference 0
12	A021	Multi-step speed reference 1
13	A023	Multi-step speed reference 2
14	A044	V/f characteristics selection
15	A045	Output voltage gain
16	A085	Energy-saving RUN mode selection
17	b001	Retry selection
18	b002	Allowable momentary power interruption time
19	b008	Trip retry selection
20	b011	Trip retry wait time
21	b037	Display selection *
22	b083	Carrier frequency
23	b084	Initialization selection
24	b130	Overvoltage protection function during deceleration
25	b131	Overvoltage protection level during deceleration
26	C021	Multi-function output terminal P1 selection
27	C022	Multi-function output terminal P2 selection
28	C036	Relay output (MA, MB) contact selection

* If the target parameter is not displayed, check the setting of display selection "b037".
 To display all parameters, set "00" to "b037".

Standard Specification List

●Three-phase 200-V Class

Class		3-phase 200 V									
Model name (3G3RX-)		A2055	A2075	A2110	A2150	A2185	A2220	A2300	A2370	A2450	A2550
Max. applicable motor 4P	kW	5.5	7.5	11	15	18.5	22	30	37	45	55
Rated output capacity (kVA)	200 V	8.3	11.0	15.9	22.1	26.3	32.9	41.9	50.2	63.0	76.2
	240 V	9.9	13.3	19.1	26.6	31.5	39.4	50.2	60.2	75.6	91.4
Rated input voltage		3-phase (3-wire) 200 V -15% to 240 V +10%, 50/60 Hz ±5%									
Rated output voltage		3-phase: 200 to 240 V (Cannot exceed that of incoming voltage.)									
Rated output current (A)		24	32	46	64	76	95	121	145	182	220
Weight (kg)		6	6	6	14	14	14	22	30	30	43
Braking	Regenerative braking	Built-in braking resistor circuit (discharge resistor separately mounted)						Regenerative braking unit separately mounted			
	Minimum connection resistance (Ω)	17	17	17	7.5	7.5	5	---			

●Three-phase 400-V Class

Class		3-phase 400 V									
Model name (3G3RX-)		A4055	A4075	A4110	A4150	A4185	A4220	A4300	A4370	A4450	A4550
Max. applicable motor 4P	kW	5.5	7.5	11	15	18.5	22	30	37	45	55
Rated output capacity (kVA)	400 V	9.7	13.1	17.3	22.1	26.3	33.2	40.1	51.9	63.0	77.6
	480 V	11.6	15.8	20.7	26.6	31.5	39.9	48.2	62.3	75.6	93.1
Rated input voltage		3-phase (3-wire) 380 V -15% to 480 V +10%, 50/60 Hz ±5%									
Rated output voltage		3-phase: 380 to 480 V (Cannot exceed that of incoming voltage.)									
Rated output current (A)		14	19	25	32	38	48	58	75	91	112
Weight (kg)		6	6	6	14	14	14	22	30	30	30
Braking	Regenerative braking	Built-in braking resistor circuit (discharge resistor)					Regenerative braking unit separately mounted				
	Minimum connection resistance (Ω)	70	35	35	24	24	20	---			

Common Specification

Item		Specifications
Enclosure rating		IP20
Cooling method		Forced air cooling
Control method		Phase-to-phase sinusoidal modulation PWM
Output frequency range		0.1 to 400Hz
Frequency precision		Digital command: ±0.01% of the max. frequency Analog command: ±0.2% of the max. frequency (25°C ±10°C)
Frequency resolution		Digital setting: 0.01 Hz Analog setting: Max. frequency/4000 (Terminal FV: 12 bits/0 to +10 V), (Terminal FV2: 12 bits/-10 to +10 V), (Terminal FI: 12 bits/0 to +20 mA)
Voltage/Frequency characteristics		V/f optionally changeable at base frequencies of 30 to 400 Hz, V/f braking constant torque, reduction torque, sensorless vector control, sensor-less vector control at 0 Hz
Speed fluctuation		±0.5% (under sensor-less vector control or sensorless vector control at 0 Hz)
Overload current rating		150%/60 s, 200%/3 s
Acceleration/Deceleration time		0.01 to 3600.0 s (line/curve selection)
Starting torque		200%/0.3 Hz (under sensorless vector control or sensor-less vector control at 0 Hz) 150%/Torque at 0 Hz (under sensor-less vector control at 0 Hz, or when the motor with one frame fewer than the maximum applicable motor is connected)
DC injection braking		Operates when the starting frequency is lower than that in deceleration via the STOP command, when the frequency reference is lower than the operation frequency, or via an external input (braking power, time, and frequency settable)
Input	Multi-function input	8 terminals, NO/NC switchable, sink/source logic switchable [Terminal function] 8 functions can be selected from among 60. Reverse (RV), Multi-step speed 1 (CF1), Multi-step speed 2 (CF2), Multi-step speed 3 (CF3), Multi-step speed 4 (CF4), Jogging (JG), External DC injection braking (DB), 2nd control (SET), 2-step acceleration/deceleration (2CH), Free-run stop (FRS), External trip (EXT), USP function (USP), Commercial switch (CS), Soft lock (SFT), Analog input selection (AT), 3rd control (SET3), Reset (RS), 3-wire startup (STA), 3-wire stop (STP), 3-wire forward/reverse (F/R), PID disabled (PID), PID integral reset (PIDC), Control gain switching (CAS), Remote operation accelerated (UP), Remote operation decelerated (DWN), Remote operation data clear (UDC), Forced operator (OPE), Multi-step speed bit 1 (SF1), Multi-step speed bit 2 (SF2), Multi-step speed bit 3 (SF3), Multi-step speed bit 4 (SF4), Multi-step speed bit 5 (SF5), Multi-step speed bit 6 (SF6), Multi-step speed bit 7 (SF7), Overload limit switching (OLR), Torque limit enabled (TL), Torque limit switching 1 (TRQ1), Torque limit switching 2 (TRQ2), P/PI switching (PPI), Brake confirmation (BOK), Orientation (ORT), LAD cancel (LAC), Position deviation clear (PCLR), Pulse train position command input permission (STAT), Frequency addition function (ADD), Forced terminal (F-TM), Torque reference input permission (ATR), Integrated power clear (KHC), Servo ON (SON), Preliminary excitation (FOC), General-purpose input 1 (MI1), General-purpose input 2 (MI2), General-purpose input 3 (MI3), General-purpose input 4 (MI4), General-purpose input 5 (MI5), General-purpose input 6 (MI6), General-purpose input 7 (MI7), General-purpose input 8 (MI8), Analog command held (AHD), No allocation (no)
	Thermistor input terminal	1 terminal (Positive/Negative temperature coefficient of resistance element switchable)
Output	Multi-function output	5 open collector output terminals: NO/NC switchable, sink/source logic switchable 1 relay (SPDT contact) output terminal: NO/NC switchable [Terminal function] 6 functions can be selected from among 43. During operation (RUN), Constant speed reached (FA1), Set frequency exceeded (FA2), Overload warning (OL), Excessive PID deviation (OD), Alarm signal (AL), Set frequency only (FA3), Overtorque (OTQ), Signal during momentary power interruption (IP), Signal during undervoltage (UV), Torque limit (TRQ), RUN time over (RNT), Power ON time over (ONT), Thermal warning (THM), Brake release (BRK), Brake error (BER), Zero-speed signal (ZS), Excessive speed deviation (DSE), Position ready (POK), Set frequency exceeded 2 (FA4), Set frequency only 2 (FA5), Overload warning 2 (OL2), PID FB status output (FBV), Network error (NDc), Logic operation output 1 (LOG1), Logic operation output 2 (LOG2), Logic operation output 3 (LOG3), Logic operation output 4 (LOG4), Logic operation output 5 (LOG5), Logic operation output 6 (LOG6), Capacitor life warning (WAC), Cooling fin overheat warning (WAF), Starting contact signal (FR), Cooling fin overheat warning (OHF), Low current signal (LOC), General-purpose output 1 (MO1), General-purpose output 2 (MO2), General-purpose output 3 (MO3), General-purpose output 4 (MO4), General-purpose output 5 (MO5), General-purpose output 6 (MO6), Operation ready (IRDY), During forward operation (FWR), During reverse operation (RVR), Fatal fault (MJA), Alarm codes 0 to 3 (AC0 to AC3)
	Multi-function monitor output terminal	Analog voltage output, Analog current output, Pulse train output (A-F, D-F {multiplied by "n", pulse output only}, A, T, V, P, etc.)
Display monitor		Output frequency, Output current, Output torque, Frequency conversion value, Trip record, I/O terminal status, Electric power, etc.
Other functions		V/f free setting (7), Upper/lower frequency limit, Frequency jump, Curve acceleration/deceleration, Manual torque boost level/break, Energy-saving operation, Analog meter adjustment, Starting frequency, Carrier frequency adjustment, Electronic thermal function, (free setting available), External start/end (frequency/rate), Analog input selection, Trip retry, Restart during momentary power interruption, Various signal outputs, Reduced voltage startup, Overload limit, Initialization value setting, Automatic deceleration at power-off, AVR function, Fuzzy acceleration/deceleration, Auto tuning (Online/Offline), High-torque multi-operation control (sensor-less vector control of two monitors with one Inverter)
Carrier frequency modification range		0.5 to 15 kHz
Protective functions		Overcurrent protection, Overvoltage protection, Undervoltage protection, Electronic thermal protection, Temperature error protection, Momentary power interruption/Power interruption protection, Input open-phase protection, Braking resistor overload protection, Ground-fault overcurrent detection at power-on, USP error, External trip, Emergency shutdown trip, CT error, Communication error, Option error, etc.

Selection

Features

SYSDRIVE
JX Series

SYSDRIVE
MX Series

SYSDRIVE
RX Series

SYSDRIVE
Option

Overview of
Inverter Selection

Item		Specifications
Operating environment	Ambient/Storage temperature/Humidity	-10°C to 50°C/-20°C to 65°C/20% to 90% RH (with no condensation)
	Vibration *	3G3RX-A055/-A075/-A110/-A150/-A185/-A220: 5.9 m/s ² (0.6G), 10 to 55 Hz 3G3RX-A300/-A370/-A450/-A550: 2.94 m/s ² (0.3G), 10 to 55 Hz
	Location	At a maximum altitude of 1,000 m; indoors (without corrosive gases or dust)
Options	Feedback option	Sensor vector control
	Digital input option	4-digit BCD, 16-bit binary
Other options		Braking resistor, AC reactor, DC reactor, Noise filter, Digital Operator cables, Harmonics suppression unit, LCR filter, Analog operation panel, Application control device, Regenerative braking unit, etc.

*Complies with the test method specified in JIS C0040 (1999).

Note: Insulation distance complies with UL/CE standards.

■ Terminal Block Specifications

● Terminal Block Position

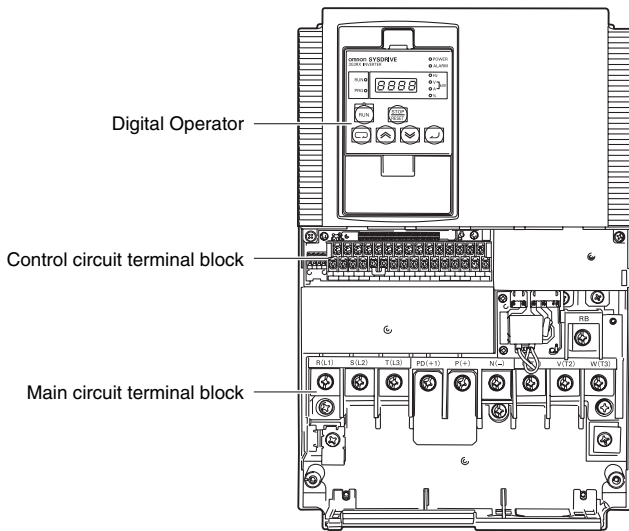

Note: This illustration shows the terminal block with the Terminal block front cover removed.

● Arrangement of Main Circuit Terminals

Terminal arrangement

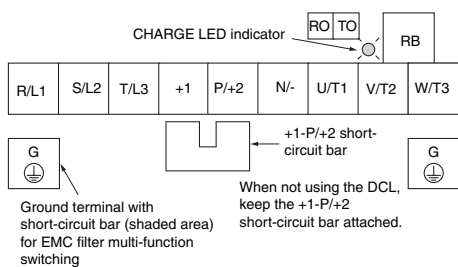

EMC filter functions switching method

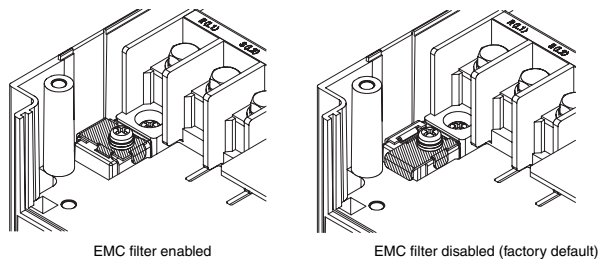

● Emergency Shutoff Function

- The built-in slide switch is used to enable or disable the emergency shutoff function (Factory Default: Disabled).
- This function is intended to turn off the Inverter output (Stop switching the main element) via only the multi-function input terminal of the hardware circuit, independent of the CPU Software.

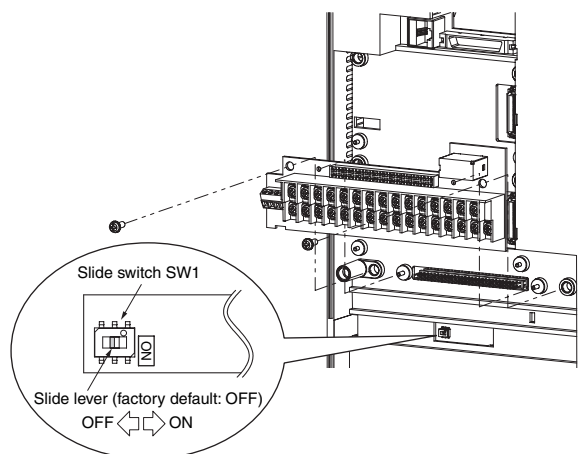

Terminal symbol	Terminal name	Description
R/L1, S/L2, T/L3	Main power supply input terminal	Connect the input power supply.
U/T1, V/T2, W/T3	Inverter output terminal	Connect to the 3-phase motor.
+1, P/+2	External DC reactor connection terminal	Remove the short-circuit bar between terminals "+1" and "P/+2", and connect the optional power factor improvement reactor (DCL).
P/+2, RB	Braking resistor connection terminals	Connect optional external braking resistors. (The RB terminal is provided for the Inverters with 22 kW or lower capacity.)
P/+2, N/-	Regenerative braking unit connection terminal	Connect optional regenerative braking units.
G	Ground terminal	Inverter case ground terminal. Connect this terminal to the ground. Class D (200 V), Class D (400 V)

●Arrangement of Control Circuit Terminals

FS	FV2	AM	FM	TH	FW	S8	SC	S5	S3	S1	P4	P3	P1	MA	
FC	FV	FI	AMI	P24	SN	SC	S7	S6	S4	S2	P5	PC	P2	MC	MB

Terminal screw size M3

		Terminal symbol	Terminal name	Description	Specifications	
Analog	Power supply	FC	Frequency reference common	Common terminal for the frequency setting signals (FV, FV2 and FI) and the analog output terminals (AM and AMI). Do not connect this terminal to the ground.	---	
		FS	Frequency reference power supply output	+10 V DC power supply for the FV terminal.	Allowable load current: 20 mA max.	
	Frequency setting input	FV	Frequency reference input (Voltage directive)	With a 0 V to 10 V DC voltage input, the maximum frequency is set at 10 V. To set the maximum frequency at 10 V or lower, set A014.	Input impedance 10 kΩ Allowable input voltage range: -0.3 to +12 V DC	
		FV2	Auxiliary frequency reference input (Voltage directive)	With a 0 to 10 V DC voltage input, the FV2 signal is added to the frequency reference signal of the FV or FI terminal. If the setting is changed, the frequency reference can be input even with the FV2 terminal independently.	Input impedance 10 kΩ Allowable input voltage 0 to ±12 V DC	
		FI	Frequency reference input (Current directive)	With a 4 to 20 mA DC current input, the maximum frequency is set at 20 mA. The FI signal is only active when the AT terminal is ON. Allocate the AT function to the multi-function input terminal.	Input impedance 100 Ω Allowable max. current: 24 mA	
	Monitor output	AM	Analog monitor (Voltage)	This terminal outputs a signal selected from the "0 V to 10 V DC Voltage Output" monitor items: Output frequency, Output current, Output torque (with/without sign), Output voltage, Input voltage, Electronic thermal relay load rate, LAD frequency, Motor temperature, Cooling fin temperature, and General-purpose output.	Allowable max. current: 2 mA	
AMI		Analog monitor (Current)	This terminal outputs a signal selected from the "4 to 20 mA DC Current Output" monitor items: Output frequency, Output current, Output torque (with/without sign), Output voltage, Input voltage, Electronic thermal relay load rate, LAD frequency, Motor temperature, Cooling fin temperature, and General-purpose output.	Allowable load impedance: 250 Ω max.		
Digital (contact)	Monitor output	FM	Multi-function digital output	This terminal outputs a signal selected from the "0 to 10 V DC Voltage Output (PWM)" monitor items: Output frequency, Output current, Output torque (with/without sign), Output voltage, Input voltage, Electronic thermal relay load rate, LAD frequency, Motor temperature, Cooling fin temperature, General-purpose output, Digital output frequency, and Digital current monitor. "Digital output frequency", and "Digital current monitor" output a digital pulse at 0/10 V DC pulse voltage and 50% duty ratio.	Allowable max. current: 1.2 mA Max. frequency: 3.6 kHz	
	Power supply	P24	Interface power supply terminal	24 V DC power supply for contact input signal. When the source logic is selected, this terminal functions as the contact input common terminal.	Allowable max. output current: 100 mA	
		SC	Input common	Common terminal for the interface power supply (P24) terminal, thermistor input (TH) terminal and digital monitor (FM) terminal. When the sink logic is selected, this terminal functions as the contact input common terminal. Do not connect this terminal to the ground.	---	
	Contact input	RUN command	FW	Forward rotation command terminal	When the FW signal is ON, the motor runs forward. When it is OFF, the motor decelerates and stops.	[Contact input ON condition] Voltage between each input terminal and the SN terminal: 18 V DC or more.
			S1	Multi-function input	Select 8 functions from among the 69 functions and allocate them to terminals S1 to S8. Note: Only terminals S1 and S3 can be used for the emergency shutoff function. For details, refer to <i>Emergency Shutoff Function</i> on page 45.	Input impedance between each input terminal and the SN terminal: 4.7 kΩ Allowable max. voltage: Voltage between each input terminal and the SN terminal: 27 V DC Load current at 27 V DC power supply voltage: Approx. 5.6 mA
		S2				
		S3				
		S4				
	S5					
	S6					
S7						
S8	Multi-function input	When the SN signal is ON, the motor runs forward. When it is OFF, the motor decelerates and stops.	---			
SN	Multi-function input common	The sink and source logic for contact input can be switched by connecting a short-circuit bar on the control terminal block. Short-circuiting P24 and SC → Sink logic, Short-circuiting SC and SN → Source logic To drive contact input via an external power supply, remove the short-circuit bar and connect terminal SN to the external interface circuit.	---			

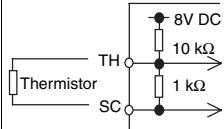
			Terminal symbol	Terminal name	Description	Specifications
Digital (contact)	Open collector output	Status/Factor	P1	Multi-function output	Select 5 functions from among 51, and allocate them to terminals P1 through P5. If an alarm code is selected in C062, terminals P1 to P3, or terminals P1 to P4 always output an alarm factor code (e.g. Inverter trip). The signal between each terminal and PC always corresponds to the sink or source logic.	Between each terminal and PC Voltage drop 4 V max. at power-on Max. allowable voltage: 27 V DC
			P2			
			P3			
			P4			
			P5			
		PC	Multi-function output common	Common terminal for multi-function output terminals P1 to P5.	Max. allowable current: 50 mA	
	Relay output	Status, alarm, etc.	MA MB	Relay output	Select the desired functions from among 43 functions, and allocate them to these terminals. SPDT output. By factory default, the relay output (MA, MB) contact selection (C036) is set at NC contact between MA-MC, and NO contact between MB-MC.	Contact max. capacity MA-MC 250 V AC, 2 A (Resistance) 0.2 A (Induction) MB-MC 250 V AC, 1 A (Resistance) 0.2 A (Induction) Contact min. capacity 100 V AC, 10 mA 5 V DC, 100 mA
MC			Relay output common			
Analog	Analog input	Sensor	TH	External thermistor input Terminal	Connect an external thermistor to this terminal, to trip the Inverter when a temperature error occurs. The SC terminal functions as the common terminal. [Recommended thermistor characteristics] Allowable rated power: 100 mW min. Impedance at temperature error: 3 kΩ Temperature error detection level is adjustable between 0 and 9999 Ω.	Allowable input voltage range 0 to 8V DC [Input circuit] 

Selection

Features

SYSDRIVE
JX Series

SYSDRIVE
MX Series

SYSDRIVE
RX Series

SYSDRIVE
Option

Overview of
Inverter Selection

Dimensions

- 3G3RX-A2055
- 3G3RX-A2075
- 3G3RX-A2110
- 3G3RX-A4055
- 3G3RX-A4075
- 3G3RX-A4110

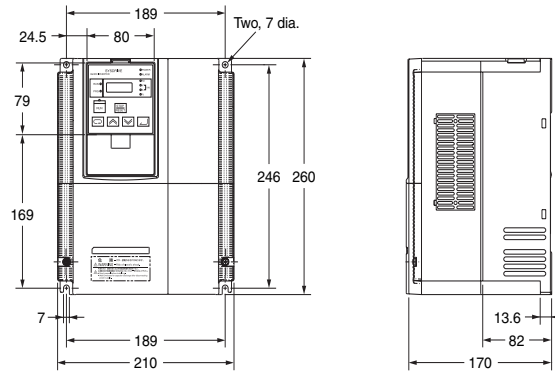

- 3G3RX-A2150
- 3G3RX-A2185
- 3G3RX-A2220
- 3G3RX-A4150
- 3G3RX-A4185
- 3G3RX-A4220

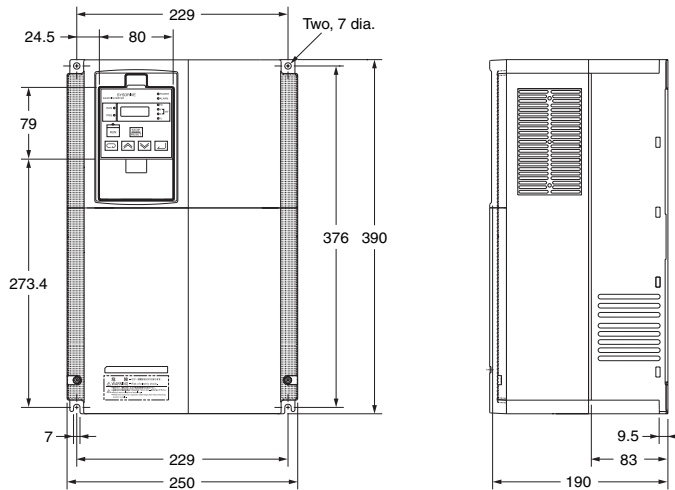

- 3G3RX-A2300
- 3G3RX-A4300

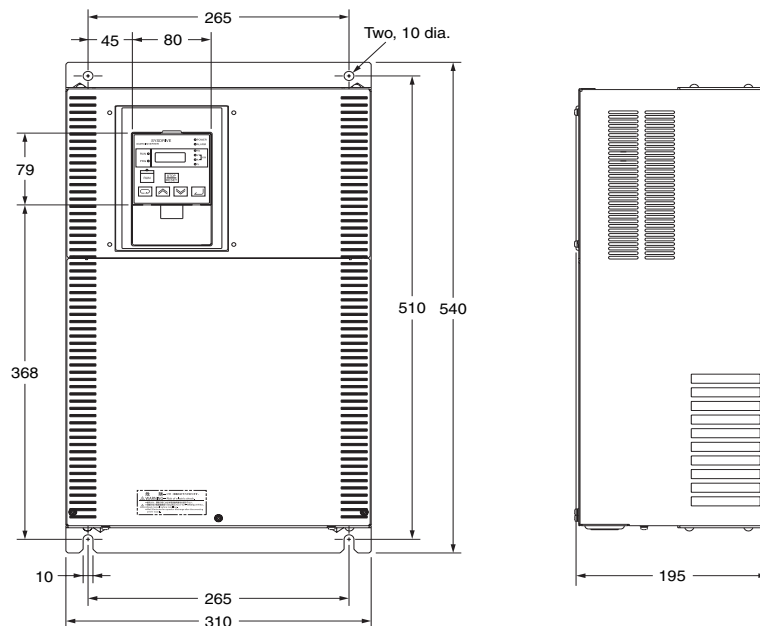

3G3RX-A2370
 3G3RX-A2450
 3G3RX-A4370
 3G3RX-A4450
 3G3RX-A4550

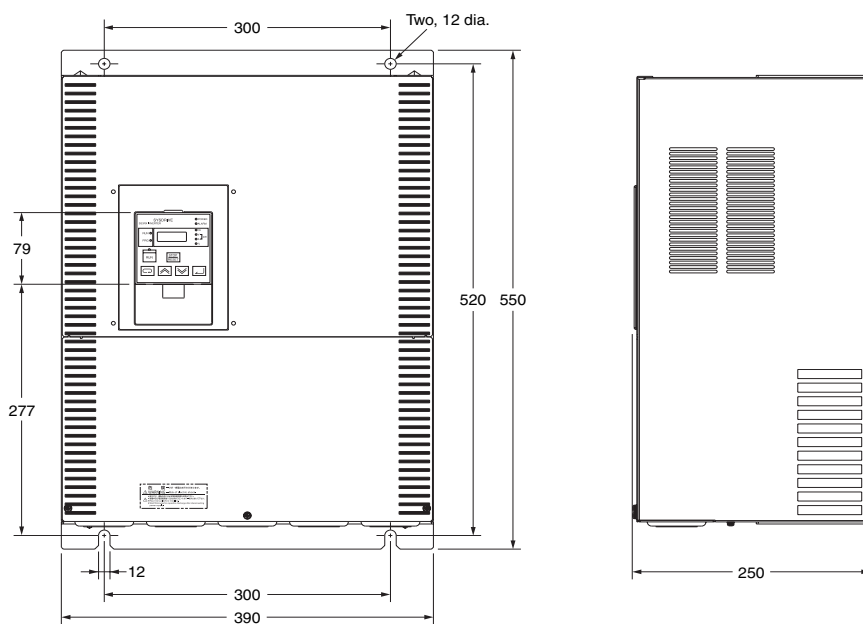

3G3RX-A2550

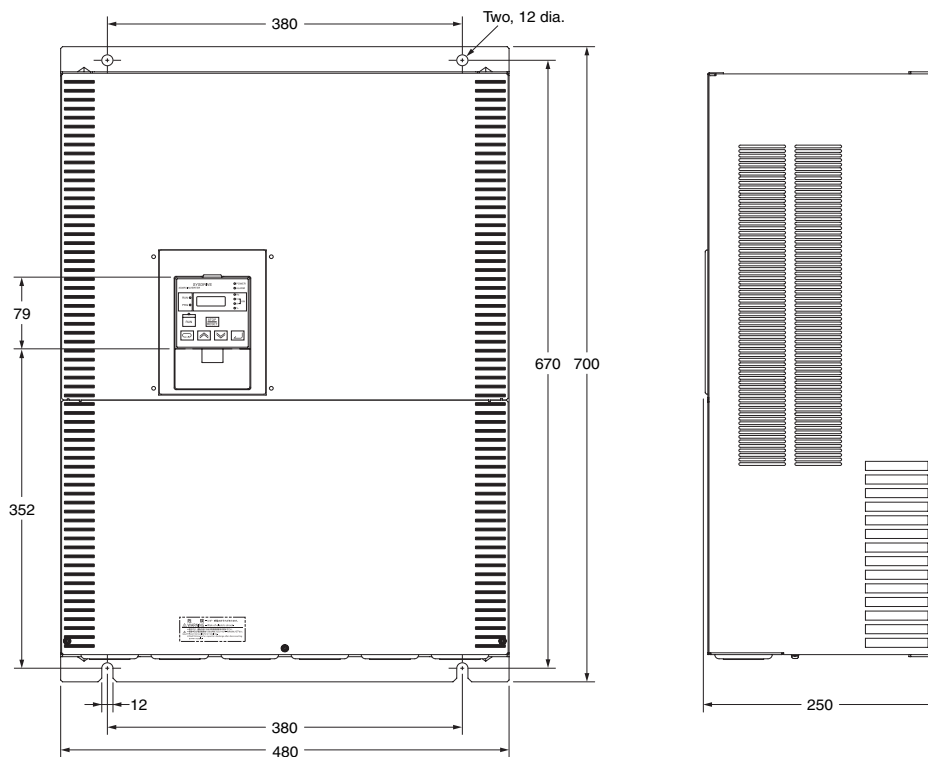

Selection

Features

SYSDRIVE
 JX Series

SYSDRIVE
 MX Series

SYSDRIVE
 RX Series

SYSDRIVE
 Option

Overview of
 Inverter Selection

Standard Connection Diagram

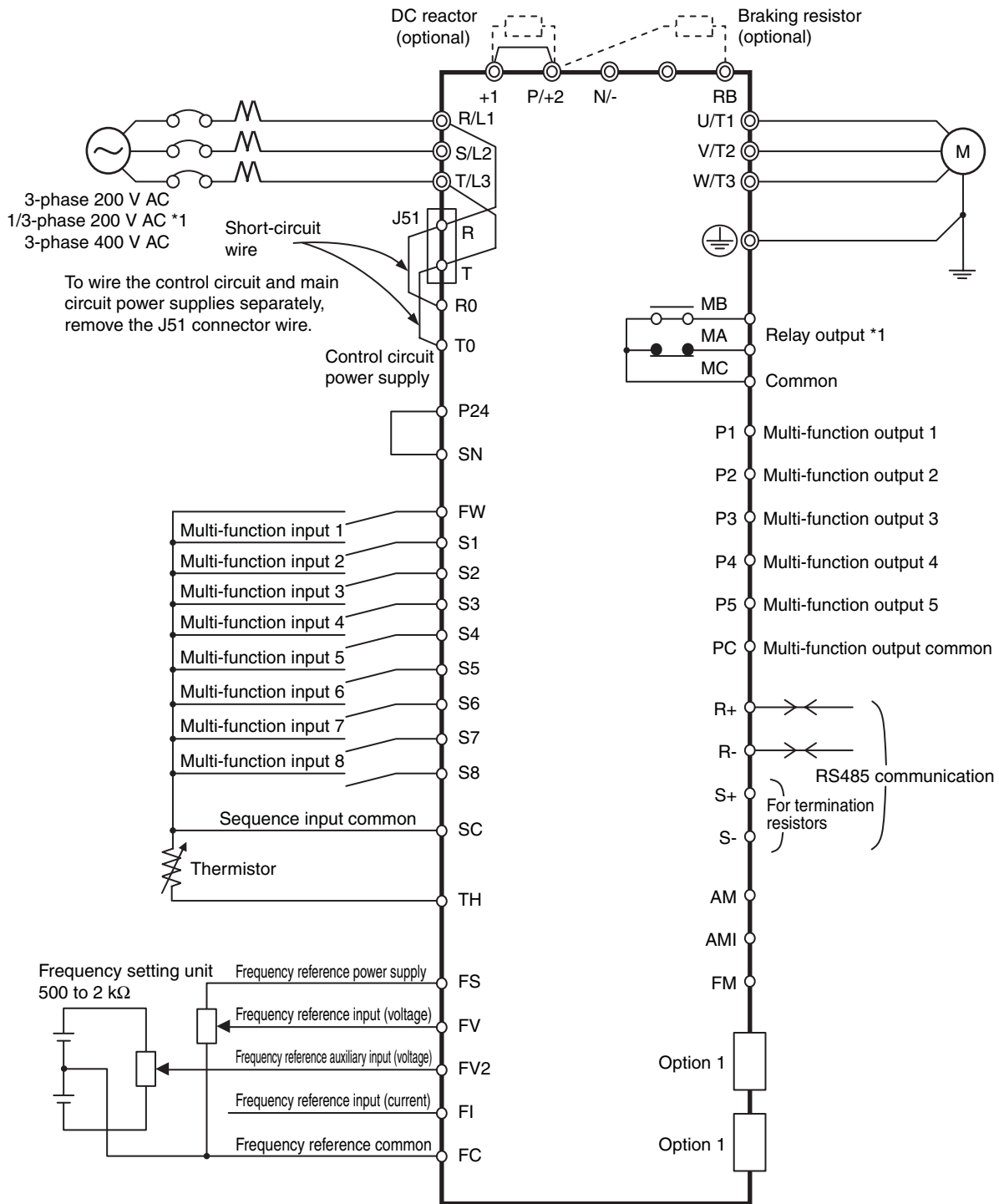





*1. By default, MA is set to NC contact, and MB to NO contact in the contact selection (C036).

Protective and Diagnostic Functions

●Error Code List

Display on Digital Operator	Name	Description	
	Overcurrent protection	Constant speed	If the motor is restrained or rapidly accelerated or decelerated, a large current will flow through the Inverter, which will result in breakage. The larger than specified current then shuts off the output and an error appears. The protection detects this overcurrent through AC CT (current detector). The protection circuit operates at approximately 220% of the Inverter rated output current and a trip occurs.
		Deceleration	
		Acceleration	
		Others	
	Overload protection ^{*1}	Monitors the Inverter output current and shuts off the output, displaying an error if the built-in electronic thermal function detects overload against the motor. Trips depending on the electronic thermal function settings.	
	Braking resistor overload protection	Shuts off the output and displays an error if the usage rate of regenerative braking circuit exceeds the b090 set value.	
	Overvoltage protection	Extremely high DC voltage between P/+2 and N/- may result in failure. This function therefore shuts off the output and displays an error if the DC voltage between P/+2 and N/- exceeds the specified level because of regenerative energy from the motor or increase of the incoming voltage during operation. Trips when the DC voltage between P/+2 and N/- reaches approximately 400 V DC for 200-V class, and 800 V DC for 400-V class.	
	EEPROM error ^{*2 *3}	Shuts off the output and displays an error if an error occurs because of external noise and abnormal temperature rise in the EEPROM built into the Inverter. Note: It may become a CPU error depending on the case.	
	Undervoltage	Shuts off the output if the incoming voltage drops below that specified. This is because the control circuit fails to work properly, if the incoming voltage to the Inverter drops. Trips when the DC voltage between P and N reaches approximately 175 V DC for 200-V class, and 345 V DC for 400-V class.	
	CT error	Shuts off the output if an error occurs in the CT (current detector) built into the Inverter. Trips if the CT output is approximately 0.6 V or more when the power is turned on.	
	CPU error ^{*3}	Shuts off the output and displays an error if the internal CPU has worked erroneously or abnormally. Note: If an abnormal value is read from EEPROM, it may become a CPU error depending on the case.	
	External trip	If an error occurs in the external equipment or devices, the Inverter receives the signal, and the output is shut off. (Available with the external trip function selected)	
	USP error	Appears when the power is turned on with the RUN signal input into the Inverter. (Available with the USP function selected)	
	Grounding protection ^{*3}	Protects the Inverter if a ground fault between the Inverter output unit and the motor is detected when turning on the power. (This function does not work when there is residual voltage in the motor.)	
	Incoming overvoltage protection	Appears if the incoming voltage continues to be higher than the specification value for 100 seconds while the Inverter is stopped. Trips when the main circuit DC voltage reaches approximately 390 V DC for 200-V class, and 780 V DC for 400-V class.	
	Momentary power interruption protection	Shuts off the output when a momentary power interruption occurs for 15 ms or more. If the shutoff time is long, it is normally recognized as a power shutoff. Note that, when restart is selected, the Inverter restarts from recovery as long as the RUN command remains.	
	Temperature error when the rotation speed of the cooling fan decreases	Appears if a decrease of the cooling fan rotation speed has been detected when the following temperature error occurs.	
	Temperature error	Shuts off the output if the temperature has risen in the main circuit because of the high ambient temperature.	
	Gate array communications error	Trips when a fault is detected in communication behavior between the built-in CPU and the gate array.	
	Input open-phase protection	Prevents Inverter damage due to input open-phase protection function when the input open-phase selection is enabled (b006=01), and trips. Trips when the open-phase time is approximately 1 s or more.	
	Main circuit error ^{*3}	Trips when the gate array cannot confirm IGBT ON/OFF because of erroneous operation or main element breakage caused by noise interfusion.	
	IGBT error	Shuts off the Inverter output to protect the main element when a momentary overcurrent, temperature error in the main element, or drop of the main element driving power supply occurs. (Retry operation cannot be performed after this trip.)	
	Thermistor error	Shuts off the Inverter output when detecting the thermistor resistance value inside the motor connected to the TH terminal and resulting motor temperature rise.	
	Brake error	When 01 is selected in b120 (brake control selection), this error appears if the brake ON/OFF cannot be recognized within the b124 set time (brake confirmation wait time) after the Inverter outputs the brake release signal.	
	Emergency shutoff ^{*4}	Shuts off the hardware output and displays an error when the EMR terminal (S3) is turned on with SW1 on the logic board ON.	
	Overload protection in a low speed range	If an overload is detected in the lowest speed range of 0.2 Hz max., an electronic thermal inside the Inverter works to shut off the Inverter output. (2nd electronic thermal level) (However, higher frequency could remain in the error history.)	
	Modbus communications error	Appears when the timeout occurs because of disconnection during Modbus-RTU communication. (Trip by the C076 setting)	

Display on Digital Operator	Name	Description
 	Option 1 error	Detects an error on the board mounted on option slot 1. For details, refer to the operation manual for the mounted option board.
 	Option 2 error	Detects an error on the board mounted on option slot 2. For details, refer to the operation manual for the mounted option board.

- *1. The reset command will not be accepted until approximately 10 seconds pass since the trip occurs (protection function works)
- *2. The reset command will not be accepted if the EEPROM error  occurs. Turn off the power once. If you find E08 when turning on the power again, it is possible that the memory element has been broken or the parameters have not been memorized correctly. Perform the user initialization to set the parameters again.
- *3. The reset command through the RS terminal or STOP/RESET key will not be accepted. Turn off the power.
- *4. The reset operation via the Digital Operator will not be accepted. Be sure to reset via the RS terminal.

Model Number Explanation

3G3RX - A □ □ □ □

RX-series
Inverter

Maximum Motor Capacity

055	5.5 kW	220	22 kW
075	7.5 kW	300	30 kW
110	11 kW	370	37 kW
150	15 kW	450	45 kW
185	18.5 kW	550	55 kW

Voltage Class

2	3-phase 200 V AC
4	3-phase 400 V AC

Standard Models

Rated voltage	Enclosure rating	Max. applicable motor capacity	Model
3-phase 200 V AC	IP20	5.5 kW	3G3RX-A2055
		7.5 kW	3G3RX-A2075
		11 kW	3G3RX-A2110
		15 kW	3G3RX-A2150
		18.5 kW	3G3RX-A2185
		22 kW	3G3RX-A2220
		30 kW	3G3RX-A2300
		37 kW	3G3RX-A2370
		45 kW	3G3RX-A2450
55 kW		3G3RX-A2550	
3-phase 400 V AC		5.5 kW	3G3RX-A4055
		7.5 kW	3G3RX-A4075
		11 kW	3G3RX-A4110
		15 kW	3G3RX-A4150
		18.5 kW	3G3RX-A4185
		22 kW	3G3RX-A4220
		30 kW	3G3RX-A4300
		37 kW	3G3RX-A4370
	45 kW	3G3RX-A4450	
55 kW	3G3RX-A4550		

International Standards (EC Directives and UL/cUL Standards)

The 3G3RX Inverter meets the EC Directives and UL/cUL standard requirements for worldwide use.

Classification		Applicable standard
ED Directives	EMC Directive	EN61800-3: 2004
	Low-voltage Directive	EN61800-5-1: 2003
UL/cUL Standards		UL508C

Specifications of Optional Items and Peripheral Devices

The following optional items and peripheral devices can be used with the Inverter. Select them according to the application.

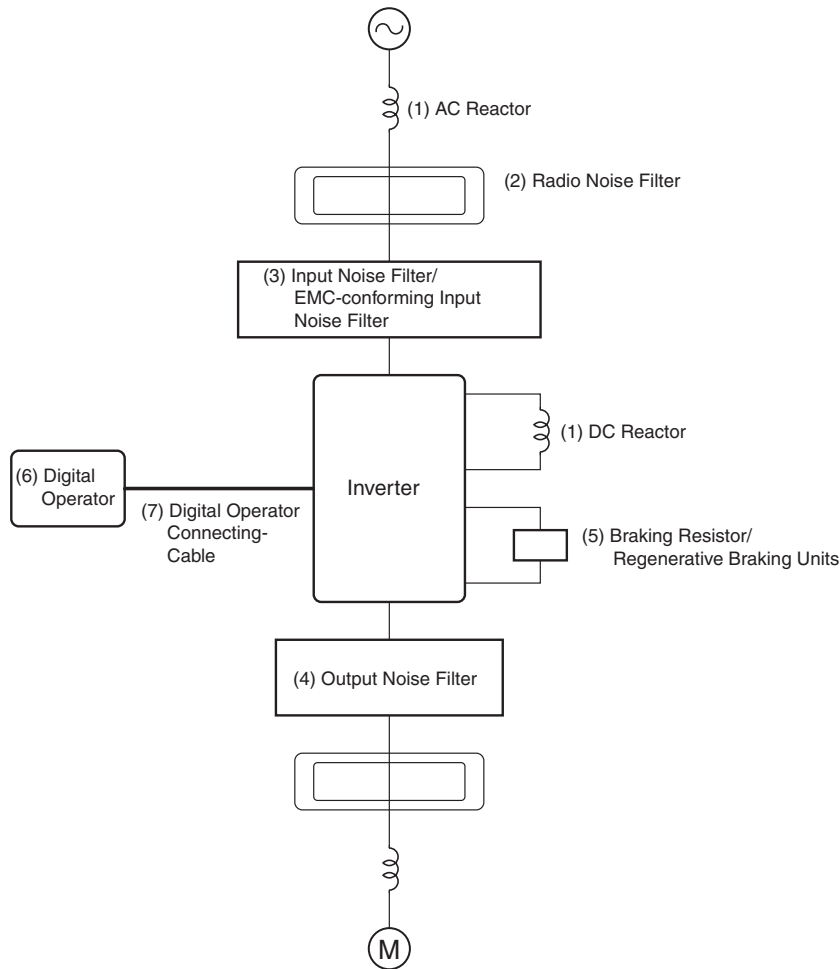

Purpose	No.	Name	Model	Description
Improve the input power factor of the Inverter	(1)	DC Reactor AC Reactor	3G3AX-DL□□□□ 3G3AX-AL□□□□	Used to improve the input power factor of the Inverter. All Inverters of 22 kW or higher contain built-in DC reactors. These are optional for Inverters of 18 kW or less. Install DC and AC reactors for applications with a large power supply capacity (600 kVA or higher).
Reduce the affects of radio and control device noise	(2)	Radio Noise Filter	3G3AX-ZCL□	Reduces noise coming into the inverter from the power supply line and to reduce noise flowing from the inverter into the power supply line. Connect as close to the Inverter as possible.
	(3)	Input Noise Filter	3G3AX-NFI□□	Reduces noise coming into the inverter from the power supply line and to reduce noise flowing from the inverter into the power supply line. Connect as close to the Inverter as possible.
		EMC-conforming Input Noise Filter	3G3AX-EFI□□	This input noise filter is for use in systems that must comply with the EC's EMC Directives. Select a filter appropriate for the Inverter model.
	(4)	Output Noise Filter	3G3AX-NFO□□	Reduces noise generated by the Inverter. Connect as close to the Inverter as possible.
Enable stopping the machine in a set time	(5)	Braking Resistor	3G3AX-RB□□□□□□	Consumes the regenerative motor energy with a resistor to reduce deceleration time (use rate: 3% ED).
		Regenerative Braking Unit	3G3AX-RBU□□	
Operates the Inverter externally	(6)	Digital Operator	3G3AX-OP□□	Remote Operator Note: MX and RX series has this operator. It's used separated the Inverter.
	(7)	Digital Operator Connecting-Cable	3G3AX-OPCN□□	Extension cable to use a Digital Operator remotely. Cable length: 1 m or 3 m
Put the Inverter on the panel by DIN Rail	---	DIN Rail Unit	3G3AX-DIN□□	---

Note: Use a ground fault interrupter with a current sensitivity of 200 mA minimum and an operating time of 0.1 s minimum to prevent operating errors. The interrupter must be suitable for high-frequency operation.

Example: NV series by Mitsubishi Electric Corporation (manufactured in or after 1998)
EG, SG series by Fuji Electric Co., Ltd. (manufactured in or after 1984)

JX/MX/RX Series Related Options

○: Release △: Available soon

Name	Model	Specifications	Applicable Series							
			JX	MX	RX					
Regenerative Braking Units	3G3AX-RBU21	3-phase 200 V	General purpose with Braking resistor			△	△	△		
	3G3AX-RBU22		High Regeneration purpose with Braking resistor			△	△	△		
	3G3AX-RBU23		General purpose for 30 kW without Braking resistor					△		
	3G3AX-RBU24		General purpose for 55 kW without Braking resistor					△		
	3G3AX-RBU41	3-phase 400 V	General purpose with Braking resistor			△	△	△		
	3G3AX-RBU42		General purpose for 30 kW without Braking resistor			△	△	△		
	3G3AX-RBU43		General purpose for 55 kW without Braking resistor					△		
Braking Resistor	3G3AX-RBA1201	Small Size: 5ED	Resistor 120 W, 180 Ω				○	○		
	3G3AX-RBA1202		Resistor 120 W, 100 Ω				○	○		
	3G3AX-RBA1203		Resistor 120 W, 5 Ω				○	○		
	3G3AX-RBA1204		Resistor 120 W, 35 Ω				○	○		
	3G3AX-RBB2001	Standard: 10ED	Resistor 200 W, 180 Ω				○	○		
	3G3AX-RBB2002		Resistor 200 W, 100 Ω				○	○		
	3G3AX-RBB3001		Resistor 300 W, 50 Ω				○	○		
	3G3AX-RBB4001	Inside Capacity: 10ED	Resistor 400 W, 35 Ω				○	○		
	3G3AX-RBC4001		Resistor 400 W, 50 Ω				○	○		
	3G3AX-RBC6001		Resistor 600 W, 35 Ω					○		
3G3AX-RBC12001	Resistor 1200 W, 17 Ω					○				
DC Reactor	3G3AX-DL2002	3-phase 200 V	0.2 kW			○	○	○		
	3G3AX-DL2004		0.4 kW			○	○	○		
	3G3AX-DL2007		0.7 kW			○	○	○		
	3G3AX-DL2015		1.5 kW			○	○	○		
	3G3AX-DL2022		2.2 kW			○	○	○		
	3G3AX-DL2037		3.7 kW			○	○	○		
	3G3AX-DL2055		5.5 kW			○	○	○		
	3G3AX-DL2075		7.5 kW			○	○	○		
	3G3AX-DL2110		11 kW					○		
	3G3AX-DL2150		15 kW					○		
	3G3AX-DL2220		22 kW					○		
	3G3AX-DL2300		30 kW					○		
	3G3AX-DL2370		37 kW					○		
	3G3AX-DL2450		45 kW					○		
	3G3AX-DL2550		55 kW					○		
	3G3AX-DL4004		3-phase 400 V	0.4 kW			○	○	○	
	3G3AX-DL4007	0.7 kW			○	○	○			
	3G3AX-DL4015	1.5 kW			○	○	○			
	3G3AX-DL4022	2.2 kW			○	○	○			
	3G3AX-DL4037	3.7 kW			○	○	○			
	3G3AX-DL4055	5.5 kW			○	○	○			
	3G3AX-DL4075	7.5 kW			○	○	○			
	3G3AX-DL4110	11 kW					○			
	3G3AX-DL4150	15 kW					○			
	3G3AX-DL4220	22 kW					○			
	3G3AX-DL4300	30 kW					○			
	3G3AX-DL4370	37 kW					○			
	3G3AX-DL4450	45 kW					○			
	3G3AX-DL4550	55 kW					○			
	Radio Noise Filter	3G3AX-ZCL1						○	○	○
		3G3AX-ZCL2						○	○	○

Selection

Features

SYSDRIVE
JX Series

SYSDRIVE
MX Series

SYSDRIVE
RX Series

SYSDRIVE
Option

Overview of
Inverter Selection

Name	Model	Specifications		Applicable Series		
				JX	MX	RX
Input Noise Filter	3G3AX-NFI21	3-phase 200 V	0.2 to 0.75 kW	○	○	○
	3G3AX-NFI22		1.5 kW	○	○	○
	3G3AX-NFI23		2.2, 3.7 kW	○	○	○
	3G3AX-NFI24		5.5 kW	○	○	○
	3G3AX-NFI25		7.5 kW	○	○	○
	3G3AX-NFI26		11 kW			○
	3G3AX-NFI27		15 kW			○
	3G3AX-NFI28		18.5 kW			○
	3G3AX-NFI29		22, 30 kW			○
	3G3AX-NFI2A		37 kW			○
	3G3AX-NFI2B	45 kW			○	
	3G3AX-NFI2C	55 kW			○	
	3G3AX-NFI41	3-phase 400 V	0.2 to 2.2 kW	○	○	○
	3G3AX-NFI42		3.7 kW	○	○	○
	3G3AX-NFI43		5.5, 7.5 kW	○	○	○
	3G3AX-NFI44		11 kW			○
	3G3AX-NFI45		15 kW			○
	3G3AX-NFI46		18.5 kW			○
	3G3AX-NFI47		22 kW			○
	3G3AX-NFI48		30 kW			○
3G3AX-NFI49	37 kW				○	
3G3AX-NFI4A	45, 55 kW				○	
Output Noise Filter	3G3AX-NFO01	1/3-phase 200 V 0.2 to 0.75 kW, 3-phase 400 V to 2.2 kW		○	○	○
	3G3AX-NFO02	1/3-phase 200 V 1.5, 2.2 kW, 3-phase 400 V 3.7 kW		○	○	○
	3G3AX-NFO03	3-phase 200 V 3.7, 5.5 kW, 3-phase 400 V 5.5 to 11 kW		○	○	○
	3G3AX-NFO04	3-phase 200 V 7.5, 11 kW, 3-phase 400 V 15 to 22 kW		○	○	○
	3G3AX-NFO05	3-phase 200 V 15 kW, 3-phase 400 V 30, 37 kW				○
	3G3AX-NFO06	3-phase 200 V 18.5, 22 kW, 3-phase 400 V 45 kW				○
	3G3AX-NFO07	3-phase 200 V 30, 37 kW, 3-phase 400 V 55, 75 kW				○
AC Reactor	3G3AX-AL2025	200 V	0.2 to 1.5 kW	○	○	○
	3G3AX-AL2055		2.2 to 3.7 kW	○	○	○
	3G3AX-AL2110		5.5 to 7.5 kW	○	○	○
	3G3AX-AL2220		11 to 15 kW			○
	3G3AX-AL2330		18.5 to 22 kW			○
	3G3AX-AL2500		30 to 37 kW			○
	3G3AX-AL2750		45 to 55 kW			○
	3G3AX-AL4025	400 V	0.4 to 1.5 kW	○	○	○
	3G3AX-AL4055		2.2 to 3.7 kW	○	○	○
	3G3AX-AL4110		5.5 to 7.5 kW	○	○	○
	3G3AX-AL4220		11 to 15 kW			○
	3G3AX-AL4330		18.5 to 22 kW			○
	3G3AX-AL4500		30 to 37 kW			○
	3G3AX-AL4750		45 to 55 kW			○
DIN Rail Unit	3G3AX-DIN11	3G3JX		△		
	3G3AX-DIN12	3G3JX		△		
	3G3AX-DIN21	3G3MX (3-phase 200 V 0.2 to 0.75 kW, 1/3-phase 200 V 0.2 to 0.4 kW)			△	
	3G3AX-DIN22	3G3MX (3-phase 200 V 1.5 to 3.7 kW, 3-phase 400 V 0.4 to 3.7 kW)			△	
Encoder Feedback Board	3G3AX-PG01	For Position or Frequency Control				△
DI Board	3G3AX-DI01	PLC I/O Interface for setting Frequency, Acceleration/Deceleration time etc				△
Digital Operator	3G3AX-OP01			○	○	○
Digital Operator Connecting Cable	3G3AX-OPCN1	Cable Length 1 m		○	○	○
	3G3AX-OPCN3	Cable Length 3 m		○	○	○

Overview of Inverter Selection

Selecting the Motor Capacity

Select a motor before selecting the Inverter. Calculate the load inertia in the application, calculate the motor capacity and torque required to handle the load, and select an appropriate motor.

Simple Selection Method (Calculation of the Required Output)

With this method, you select the motor based on the output (W) required when the motor is rotating at a steady rate. This method does not include the involved calculations for acceleration and deceleration, so add some extra capacity to the calculated value when selecting the motor. This is a simple way to calculate the size of motor needed in equipment that operates at a steady rate for long periods, such as fans, conveyors, and mixing machines. This method is not suitable for the following kinds of applications:

- Applications requiring sudden start-ups
- Applications where the equipment starts and stops frequently
- Applications where there is a lot of inertia in the transmission system
- Applications with a very inefficient transmission system

Linear Motion: Steady Power P_0 (kW)

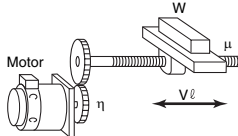

$$P_0 = \frac{m \cdot W \cdot V\ell}{6120 \cdot \eta}$$

μ : Friction coefficient
 W : Weight of moveable load (kg)
 $V\ell$: Speed of moveable load (m/min)
 η : Efficiency of reduction mechanism (transmission)

Rotational Motion: Steady Power P_0 (kW)

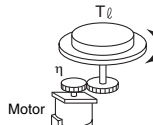

$$P_0 = \frac{T\ell \cdot N\ell}{9535 \cdot \eta}$$

$T\ell$: Load torque at load axis (N·m)
 $N\ell$: Speed of load axis (r/min)
 η : Efficiency of reduction mechanism (transmission)

Detailed Selection Method (R.M.S. Calculation Method)

With this method, you calculate the effective torque and maximum torque required in the application's operating pattern. This method provides a detailed motor selection that matches the operating pattern.

Calculating the Motor Shaft Conversion Inertia

Use the following equations to calculate the inertia of all of the parts and convert that to the motor shaft conversion inertia.

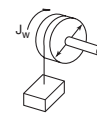

$$J_w = J_1 + J_2 = \left(\frac{M_1 \cdot D^2}{8} + \frac{M_2 \cdot D^2}{4} \right) \times 10^{-6} \text{ (kg}\cdot\text{m}^2)$$

J_w : Inertia (kg·m²)
 J_1 : Inertia of cylinder (kg·m²)
 J_2 : Inertia due to object (kg·m²)
 D : Diameter (mm)
 M_1 : Mass of cylinder (kg)
 M_2 : Mass of object (kg)

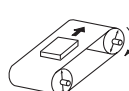

$$J_w = J_1 + J_2 + J_3 + J_4 = \left(\frac{M_1 \cdot D_1^2}{8} + \frac{M_2 \cdot D_2^2}{8} + \frac{D_1^2}{D^2} + \frac{M_3 \cdot D_1^2}{4} + \frac{M_4 \cdot D_1^2}{4} \right) \times 10^{-6} \text{ (kg}\cdot\text{m}^2)$$

J_w : Inertia (kg·m²)
 J_1 : Inertia of cylinder 1 (kg·m²)
 J_2 : Inertia of cylinder 2 (kg·m²)
 J_3 : Inertia due to object (kg·m²)
 J_4 : Inertia due to belt (kg·m²)
 D_1 : Diameter of cylinder 1 (mm)
 D_2 : Diameter of cylinder 2 (mm)
 M_1 : Mass of cylinder 1 (kg)
 M_2 : Mass of cylinder 2 (kg)
 M_3 : Mass of object (kg)
 M_4 : Mass of belt (kg)

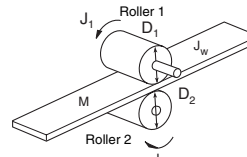

$$J_w = J_1 + \left(\frac{D_1}{D_2} \right)^2 J_2 + \frac{M \cdot D_1^2}{4} \times 10^{-6} \text{ (kg}\cdot\text{m}^2)$$

J_w : Inertia of entire system (kg·m²)
 J_1 : Inertia of roller 1 (kg·m²)
 J_2 : Inertia of roller 2 (kg·m²)
 D_1 : Diameter of roller 1 (mm)
 D_2 : Diameter of roller 2 (mm)
 M : Effective mass of workpiece (kg)

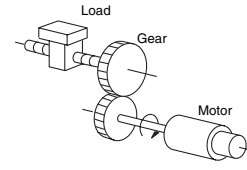

$$J_L = J_1 + G^2 (J_2 + J_w) \text{ (kg}\cdot\text{m}^2)$$

J_L : Motor shaft conversion load inertia (kg·m²)
 J_w : Load inertia (kg·m²)
 J_1 : Motor gear inertia (kg·m²)
 J_2 : Load gear inertia (kg·m²)
 Z_1 : Number of gear teeth on motor side
 Z_2 : Number of gear teeth on load side
 Gear ratio $G = Z_1/Z_2$

Calculating the Motor Shaft Conversion Torque and Effective Torque

Calculate the total combined torque required for the motor to operate based on the acceleration torque due to the motor shaft conversion load inertia (calculated above) and the load torque due to friction force and the external force applied to the load.

Acceleration Torque

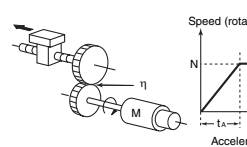
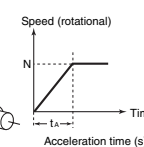



Acceleration Torque (T_A)

$$T_A = \frac{2\pi N}{60 t_a} \left(J_w + \frac{J_L}{\eta} \right) \text{ (N}\cdot\text{m)}$$

T_A : Acceleration Torque (N·m)
 J_L : Motor shaft conversion load inertia (kg·m²)
 J_w : Inertia of motor itself (kg·m²)
 η : Gear transmission efficiency
 N : Motor speed (r/min)

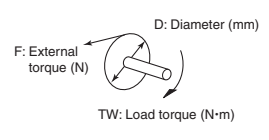
Motor Conversion Load Torque (External and Friction)



$$T_w = F \cdot \frac{D}{2} \times 10^{-3} \text{ (N}\cdot\text{m)}$$

Friction force in general:

$$F = \mu W$$

μ : Friction coefficient
 W : Weight of moving parts

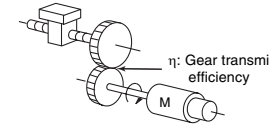

$$T_L = T_w \cdot \frac{G}{\eta} \text{ (N}\cdot\text{m)}$$

T_L : Motor shaft conversion load torque (N·m)
 T_w : Load torque (N·m)
 Z_1 : Number of gear teeth on motor side
 Z_2 : Number of gear teeth on load side
 Gear (reduction) ratio $G = Z_1/Z_2$

● Calculating the Combined Torque and Effective Torque

Effective torque: T_{RMS} (N·m)

$$= \sqrt{\frac{\sum(T_i)^2 \cdot t_i}{\sum t_i}} = \sqrt{\frac{T_1^2 \cdot t_1 + T_2^2 \cdot t_2 + T_3^2 \cdot t_3 + T_4^2 \cdot t_4}{t_1 + t_2 + t_3 + t_4}}$$

Maximum torque: $T_{MAX} = T_1 = T_A + T_L$

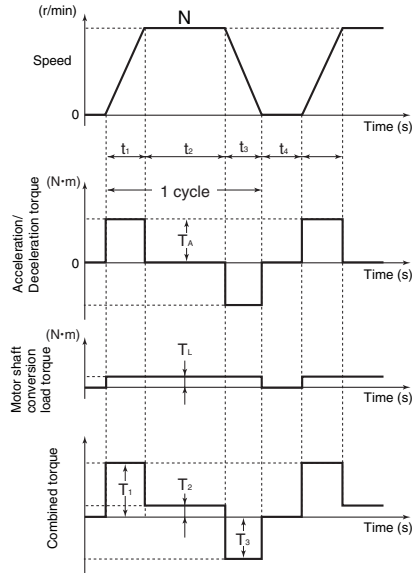

* Use the Servomotor's Motor Selection Software to calculate the motor conversion inertia, effective torque, and maximum torque shown above.

● Selecting the Motor

Use the results of the calculations above and the equations below to determine the required motor capacity from the effective torque and maximum torque. Use the larger of the following motor capacities when selecting the motor.

When selecting the motor, set a motor capacity higher than the calculated capacity to provide some extra capacity.

● Motor Capacity Supplied for Effective Torque:

Motor capacity (kW): $1.048 \cdot N \cdot T_{RMS} \cdot 10^{-4}$

(N: Max. speed in r/min)

● Motor Capacity Supplied for Maximum Torque:

Motor capacity (kW): $1.048 \cdot N \cdot T_{MAX} \cdot 10^{-4} / 1.5$

(N: Max. speed in r/min)

Selecting the Inverter Capacity

Select an Inverter that is large enough to handle the motor selected in *Selecting the Motor* above. Basically, select an Inverter with a maximum motor capacity that matches the motor capacity calculated above.

After selecting the Inverter, verify that the following conditions are satisfied. If the conditions are not satisfied, select the Inverter that is one size larger and check the conditions again.

- Motor's rated current \leq Inverter's rated output current
- The application's continuous maximum torque output time \leq 1 minute

Note 1. If the Inverter's overload endurance is 120% of the rated output current for one minute, check for 0.8 minute.

2. Use an Inverter that is one size larger than determined by the conditions above if open-loop vector control with PG is being used and a holding torque is required at 0 r/min or a torque that is 150% or more of the rated torque is required regularly at low frequencies (10 Hz or less).

Overview of Inverter Selection

Overview of Braking Resistor Selection

■ Applications Requiring Braking Resistors

In applications where excessive regenerative motor energy is produced during deceleration or descent, the main-circuit voltage in the Inverter may rise high enough to damage the Inverter. Standard Inverters are equipped with an overvoltage protection function so the main-circuit overvoltage (OV) is detected and operation is stopped to prevent damage. Although the Inverter will be protected, the overvoltage protection function will generate an error and the motor will stop; this system configuration will not provide stable continuous operation.

● About Regenerative Energy

The load connected to the motor has kinetic energy if it is rotating or potential energy if it is at a high level. The kinetic or potential energy is returned to the Inverter when the motor decelerates or lowers the load. This phenomenon is known as regeneration and the returned energy is called regenerative energy.

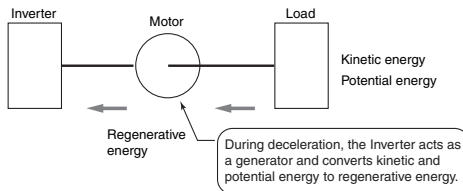

● Avoiding the Use of a Braking Resistor

The following methods can be used to avoid having to connect a Braking Resistor. These methods require the deceleration time to be extended, so you must evaluate whether extending the deceleration time will cause any problems in the application.

- Enable the "stall prevention during deceleration" function; the default setting for this function is enabled. (The deceleration time is extended automatically to prevent main-circuit overvoltage from occurring.)
- Set a longer deceleration time. (This reduces the rate at which the regenerative energy is produced.)
- Select "coast to stop" as the stopping method. (Regenerative energy will not be returned to the Inverter.)

■ Simple Method for Braking Resistor Selection

This is a simple method for determining the braking resistance from the percentage of time that regenerative energy is produced during a normal operating pattern.

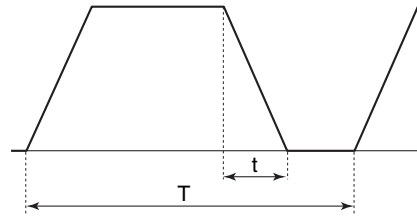

$$\text{Use rate (duty)} = t/T \times 100 (\%ED)$$

t: Deceleration time (regenerative time)

T: Time for 1 cycle of operation

■ Detailed Method for Braking Resistor Selection

If the Braking Resistor's use rate (duty factor) exceeds 10% ED or the application requires an extremely large braking torque, use the following method to calculate the regenerative energy and select a Braking Resistor.

● Calculating the Required Braking Resistance

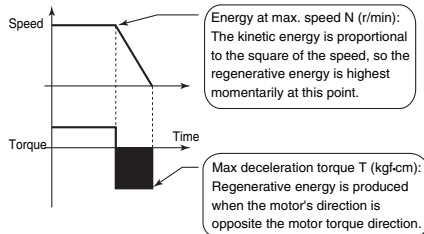

$$\text{Braking Resistor's resistance: } R \leq \frac{V^2}{1.048 \times (T - 0.2 \times T_m) \times N \times 10^{-1}}$$

V: 385 V for a 200-V Class Inverter

400 V for a 400-V Class Inverter

T: Maximum braking torque (kgf·cm)

T_m: Motor's rated torque (N·cm)

N: Maximum speed (r/min)

* Use the value for the braking torque calculated in *Calculating the Motor Shaft Conversion Torque and Effective Torque* on page 58.

● Calculating the Average Regenerative Energy

Regenerative energy is produced when the motor is rotating in the opposite direction of the motor torque. Use the following equations to calculate the regenerative energy produced in each segment of the cycle.

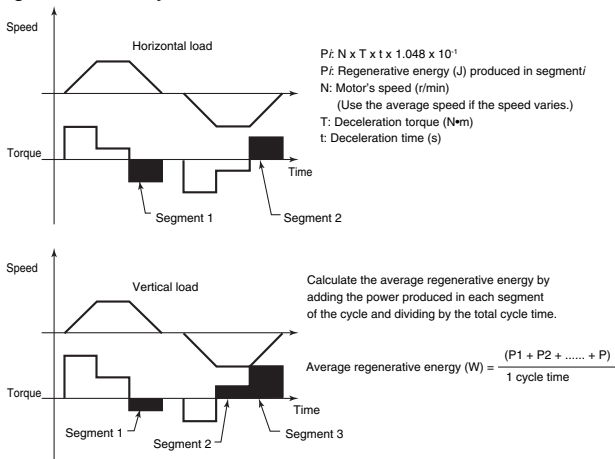

- Note 1.** The speed is positive when the motor is rotating forward and the torque is positive when it is in the forward direction.
- 2.** Use the value for the braking torque calculated in *Calculating the Motor Shaft Conversion Torque and Effective Torque* on page 58.

● Selecting the Braking Resistor

Select the appropriate Braking Resistor based on the required braking resistance and average regenerative energy that were calculated above.

- Required braking resistance \geq Braking Resistor Unit's resistance \geq Inverter or Braking Unit's minimum resistance
- Average regenerative energy \leq Braking Resistor Unit's allowable power

Note 1. The internal braking transistor will be damaged if a resistor is connected with a resistance below the Inverter or Braking Unit's minimum resistance. If the required resistance is less than the minimum resistance, increase the Inverter's capacity and replace the Inverter or Braking Unit with one that has a minimum resistance less than the required resistance.

2. Two or more Braking Units can be connected in parallel. Use the following equation to determine the braking resistance when driving two or more Units.

$$\text{Braking resistance } (\Omega) = (\text{required braking resistance calculated above}) \times (\text{number of Units})$$

3. Do not select the braking resistance with the results calculated above. A rating of 150 W is not the allowed power, it is the maximum rated power in resistor units. The actual allowed power rating depends upon the resistor.

Read and Understand this Catalog

Please read and understand this catalog before purchasing the product. Please consult your OMRON representative if you have any questions or comments.

Warranty and Limitations of Liability

WARRANTY

OMRON's exclusive warranty is that the products are free from defects in materials and workmanship for a period of one year (or other period if specified) from date of sale by OMRON.

OMRON MAKES NO WARRANTY OR REPRESENTATION, EXPRESS OR IMPLIED, REGARDING NON-INFRINGEMENT, MERCHANTABILITY, OR FITNESS FOR PARTICULAR PURPOSE OF THE PRODUCTS. ANY BUYER OR USER ACKNOWLEDGES THAT THE BUYER OR USER ALONE HAS DETERMINED THAT THE PRODUCTS WILL SUITABLY MEET THE REQUIREMENTS OF THEIR INTENDED USE. OMRON DISCLAIMS ALL OTHER WARRANTIES, EXPRESS OR IMPLIED.

LIMITATIONS OF LIABILITY

OMRON SHALL NOT BE RESPONSIBLE FOR SPECIAL, INDIRECT, OR CONSEQUENTIAL DAMAGES, LOSS OF PROFITS, OR COMMERCIAL LOSS IN ANY WAY CONNECTED WITH THE PRODUCTS, WHETHER SUCH CLAIM IS BASED ON CONTRACT, WARRANTY, NEGLIGENCE, OR STRICT LIABILITY.

In no event shall the responsibility of OMRON for any act exceed the individual price of the product on which liability is asserted.

IN NO EVENT SHALL OMRON BE RESPONSIBLE FOR WARRANTY, REPAIR, OR OTHER CLAIMS REGARDING THE PRODUCTS UNLESS OMRON'S ANALYSIS CONFIRMS THAT THE PRODUCTS WERE PROPERLY HANDLED, STORED, INSTALLED, AND MAINTAINED AND NOT SUBJECT TO CONTAMINATION, ABUSE, MISUSE, OR INAPPROPRIATE MODIFICATION OR REPAIR.

Application Considerations

SUITABILITY FOR USE

OMRON shall not be responsible for conformity with any standards, codes, or regulations that apply to the combination of products in the customer's application or use of the products.

Take all necessary steps to determine the suitability of the product for the systems, machines, and equipment with which it will be used.

Know and observe all prohibitions of use applicable to this product.

NEVER USE THE PRODUCTS FOR AN APPLICATION INVOLVING SERIOUS RISK TO LIFE OR PROPERTY WITHOUT ENSURING THAT THE SYSTEM AS A WHOLE HAS BEEN DESIGNED TO ADDRESS THE RISKS, AND THAT THE OMRON PRODUCTS ARE PROPERLY RATED AND INSTALLED FOR THE INTENDED USE WITHIN THE OVERALL EQUIPMENT OR SYSTEM.

PROGRAMMABLE PRODUCTS

OMRON shall not be responsible for the user's programming of a programmable product, or any consequence thereof.

Disclaimers

CHANGE IN SPECIFICATIONS

Product specifications and accessories may be changed at any time based on improvements and other reasons.

It is our practice to change model numbers when published ratings or features are changed, or when significant construction changes are made. However, some specifications of the products may be changed without any notice. When in doubt, special model numbers may be assigned to fix or establish key specifications for your application on your request. Please consult with your OMRON representative at any time to confirm actual specifications of purchased products.

DIMENSIONS AND WEIGHTS

Dimensions and weights are nominal and are not to be used for manufacturing purposes, even when tolerances are shown.

PERFORMANCE DATA

Performance data given in this catalog is provided as a guide for the user in determining suitability and does not constitute a warranty. It may represent the result of OMRON's test conditions, and the users must correlate it to actual application requirements. Actual performance is subject to the OMRON Warranty and Limitations of Liability.

Terms and Conditions of Sale

- Offer; Acceptance.** These terms and conditions (these "Terms") are deemed part of all quotes, agreements, purchase orders, acknowledgments, price lists, catalogs, manuals, brochures and other documents, whether electronic or in writing, relating to the sale of products or services (collectively, the "Products") by Omron Electronics LLC and its subsidiary companies ("Omron"). Omron objects to any terms or conditions proposed in Buyer's purchase order or other documents which are inconsistent with, or in addition to, these Terms.
- Prices; Payment Terms.** All prices stated are current, subject to change without notice by Omron. Omron reserves the right to increase or decrease prices on any unshipped portions of outstanding orders. Payments for Products are due net 30 days unless otherwise stated in the invoice.
- Discounts.** Cash discounts, if any, will apply only on the net amount of invoices sent to Buyer after deducting transportation charges, taxes and duties, and will be allowed only if (i) the invoice is paid according to Omron's payment terms and (ii) Buyer has no past due amounts.
- Interest.** Omron, at its option, may charge Buyer 1-1/2% interest per month or the maximum legal rate, whichever is less, on any balance not paid within the stated terms.
- Orders.** Omron will accept no order less than \$200 net billing.
- Governmental Approvals.** Buyer shall be responsible for, and shall bear all costs involved in, obtaining any government approvals required for the importation or sale of the Products.
- Taxes.** All taxes, duties and other governmental charges (other than general real property and income taxes), including any interest or penalties thereon, imposed directly or indirectly on Omron or required to be collected directly or indirectly by Omron for the manufacture, production, sale, delivery, importation, consumption or use of the Products sold hereunder (including customs duties and sales, excise, use, turnover and license taxes) shall be charged to and remitted by Buyer to Omron.
- Financial.** If the financial position of Buyer at any time becomes unsatisfactory to Omron, Omron reserves the right to stop shipments or require satisfactory security or payment in advance. If Buyer fails to make payment or otherwise comply with these Terms or any related agreement, Omron may (without liability and in addition to other remedies) cancel any unshipped portion of Products sold hereunder and stop any Products in transit until Buyer pays all amounts, including amounts payable hereunder, whether or not then due, which are owing to it by Buyer. Buyer shall in any event remain liable for all unpaid accounts.
- Cancellation; Etc.** Orders are not subject to rescheduling or cancellation unless Buyer indemnifies Omron against all related costs or expenses.
- Force Majeure.** Omron shall not be liable for any delay or failure in delivery resulting from causes beyond its control, including earthquakes, fires, floods, strikes or other labor disputes, shortage of labor or materials, accidents to machinery, acts of sabotage, riots, delay in or lack of transportation or the requirements of any government authority.
- Shipping; Delivery.** Unless otherwise expressly agreed in writing by Omron:
 - Shipments shall be by a carrier selected by Omron; Omron will not drop ship except in "break down" situations.
 - Such carrier shall act as the agent of Buyer and delivery to such carrier shall constitute delivery to Buyer;
 - All sales and shipments of Products shall be FOB shipping point (unless otherwise stated in writing by Omron), at which point title and risk of loss shall pass from Omron to Buyer; provided that Omron shall retain a security interest in the Products until the full purchase price is paid;
 - Delivery and shipping dates are estimates only; and
 - Omron will package Products as it deems proper for protection against normal handling and extra charges apply to special conditions.
- Claims.** Any claim by Buyer against Omron for shortage or damage to the Products occurring before delivery to the carrier must be presented in writing to Omron within 30 days of receipt of shipment and include the original transportation bill signed by the carrier noting that the carrier received the Products from Omron in the condition claimed.
- Warranties.** (a) **Exclusive Warranty.** Omron's exclusive warranty is that the Products will be free from defects in materials and workmanship for a period of twelve months from the date of sale by Omron (or such other period expressed in writing by Omron). Omron disclaims all other warranties, express or implied. (b) **Limitations.** OMRON MAKES NO WARRANTY OR REPRESENTATION, EXPRESS OR IMPLIED, ABOUT NON-INFRINGEMENT, MERCHANTABILITY OR FITNESS FOR A PARTICULAR PURPOSE OF THE PRODUCTS. BUYER ACKNOWLEDGES THAT IT ALONE HAS DETERMINED THAT THE PRODUCTS WILL SUITABLY MEET THE REQUIREMENTS OF THEIR INTENDED USE. Omron further disclaims all warranties and responsibility of any type for claims or expenses based on infringement by the Products or otherwise of any intellectual property right. (c) **Buyer Remedy.** Omron's sole obligation hereunder shall be, at Omron's election, to (i) replace (in the form originally shipped with Buyer responsible for labor charges for removal or replacement thereof) the non-complying Product, (ii) repair the non-complying Product, or (iii) repay or credit Buyer an amount equal to the purchase price of the non-complying Product; provided that in no event shall Omron be responsible for warranty, repair, indemnity or any other claims or expenses regarding the Products unless Omron's analysis confirms that the Products were properly handled, stored, installed and maintained and not subject to contamination, abuse, misuse or inappropriate modification. Return of any Products by Buyer must be approved in writing by Omron before shipment. Omron Companies shall not be liable for the suitability or unsuitability or the results from the use of Products in combination with any electrical or electronic components, circuits, system assemblies or any other materials or substances or environments. Any advice, recommendations or information given orally or in writing, are not to be construed as an amendment or addition to the above warranty. See <http://www.omron247.com> or contact your Omron representative for published information.
- Limitation on Liability; Etc.** OMRON COMPANIES SHALL NOT BE LIABLE FOR SPECIAL, INDIRECT, INCIDENTAL, OR CONSEQUENTIAL DAMAGES, LOSS OF PROFITS OR PRODUCTION OR COMMERCIAL LOSS IN ANY WAY CONNECTED WITH THE PRODUCTS, WHETHER SUCH CLAIM IS BASED IN CONTRACT, WARRANTY, NEGLIGENCE OR STRICT LIABILITY. Further, in no event shall liability of Omron Companies exceed the individual price of the Product on which liability is asserted.
- Indemnities.** Buyer shall indemnify and hold harmless Omron Companies and their employees from and against all liabilities, losses, claims, costs and expenses (including attorney's fees and expenses) related to any claim, investigation, litigation or proceeding (whether or not Omron is a party) which arises or is alleged to arise from Buyer's acts or omissions under these Terms or in any way with respect to the Products. Without limiting the foregoing, Buyer (at its own expense) shall indemnify and hold harmless Omron and defend or settle any action brought against such Companies to the extent based on a claim that any Product made to Buyer specifications infringed intellectual property rights of another party.
- Property; Confidentiality.** Any intellectual property in the Products is the exclusive property of Omron Companies and Buyer shall not attempt to duplicate it in any way without the written permission of Omron. Notwithstanding any charges to Buyer for engineering or tooling, all engineering and tooling shall remain the exclusive property of Omron. All information and materials supplied by Omron to Buyer relating to the Products are confidential and proprietary, and Buyer shall limit distribution thereof to its trusted employees and strictly prevent disclosure to any third party.
- Export Controls.** Buyer shall comply with all applicable laws, regulations and licenses regarding (i) export of products or information; (ii) sale of products to "forbidden" or other proscribed persons; and (iii) disclosure to non-citizens of regulated technology or information.
- Miscellaneous.** (a) **Waiver.** No failure or delay by Omron in exercising any right and no course of dealing between Buyer and Omron shall operate as a waiver of rights by Omron. (b) **Assignment.** Buyer may not assign its rights hereunder without Omron's written consent. (c) **Law.** These Terms are governed by the law of the jurisdiction of the home office of the Omron company from which Buyer is purchasing the Products (without regard to conflict of law principles). (d) **Amendment.** These Terms constitute the entire agreement between Buyer and Omron relating to the Products, and no provision may be changed or waived unless in writing signed by the parties. (e) **Severability.** If any provision hereof is rendered ineffective or invalid, such provision shall not invalidate any other provision. (f) **Setoff.** Buyer shall have no right to set off any amounts against the amount owing in respect of this invoice. (g) **Definitions.** As used herein, "including" means "including without limitation"; and "Omron Companies" (or similar words) mean Omron Corporation and any direct or indirect subsidiary or affiliate thereof.

Certain Precautions on Specifications and Use

- Suitability of Use.** Omron Companies shall not be responsible for conformity with any standards, codes or regulations which apply to the combination of the Product in the Buyer's application or use of the Product. At Buyer's request, Omron will provide applicable third party certification documents identifying ratings and limitations of use which apply to the Product. This information by itself is not sufficient for a complete determination of the suitability of the Product in combination with the end product, machine, system, or other application or use. Buyer shall be solely responsible for determining appropriateness of the particular Product with respect to Buyer's application, product or system. Buyer shall take application responsibility in all cases but the following is a non-exhaustive list of applications for which particular attention must be given:
 - Outdoor use, uses involving potential chemical contamination or electrical interference, or conditions or uses not described in this document.
 - Use in consumer products or any use in significant quantities.
 - Energy control systems, combustion systems, railroad systems, aviation systems, medical equipment, amusement machines, vehicles, safety equipment, and installations subject to separate industry or government regulations.
 - Systems, machines and equipment that could present a risk to life or property. Please know and observe all prohibitions of use applicable to this Product.

NEVER USE THE PRODUCT FOR AN APPLICATION INVOLVING SERIOUS RISK TO LIFE OR PROPERTY OR IN LARGE QUANTITIES WITHOUT ENSURING THAT THE SYSTEM AS A WHOLE HAS BEEN DESIGNED TO ADDRESS THE RISKS, AND THAT THE OMRON'S PRODUCT IS PROPERLY RATED AND INSTALLED FOR THE INTENDED USE WITHIN THE OVERALL EQUIPMENT OR SYSTEM.
- Programmable Products.** Omron Companies shall not be responsible for the user's programming of a programmable Product, or any consequence thereof.
- Performance Data.** Data presented in Omron Company websites, catalogs and other materials is provided as a guide for the user in determining suitability and does not constitute a warranty. It may represent the result of Omron's test conditions, and the user must correlate it to actual application requirements. Actual performance is subject to the Omron's Warranty and Limitations of Liability.
- Change in Specifications.** Product specifications and accessories may be changed at any time based on improvements and other reasons. It is our practice to change part numbers when published ratings or features are changed, or when significant construction changes are made. However, some specifications of the Product may be changed without any notice. When in doubt, special part numbers may be assigned to fix or establish key specifications for your application. Please consult with your Omron's representative at any time to confirm actual specifications of purchased Product.
- Errors and Omissions.** Information presented by Omron Companies has been checked and is believed to be accurate; however, no responsibility is assumed for clerical, typographical or proofreading errors or omissions.



Automation...simple...powerful.

OMRON ELECTRONICS LLC • THE AMERICAS HEADQUARTERS

Schaumburg, IL USA • 847.843.7900 • 800.556.6766 • www.omron247.com

OMRON CANADA, INC. • HEAD OFFICE

Toronto, ON, Canada • 416.286.6465 • 866.986.6766 • www.omron.ca

OMRON ELETRÔNICA DO BRASIL LTDA • HEAD OFFICE

São Paulo, SP, Brasil • 55.11.2101.6300 • www.omron.com.br

OMRON ELECTRONICS MEXICO SA DE CV • HEAD OFFICE

Apodaca, N.L. • 52.811.156.99.10 • mela@omron.com

OMRON ARGENTINA • SALES OFFICE

Cono Sur • 54.11.4787.1129

OMRON CHILE • SALES OFFICE

Santiago 56.2206.4592

OTHER OMRON LATIN AMERICA SALES

56.2206.4592